

Brian Wells

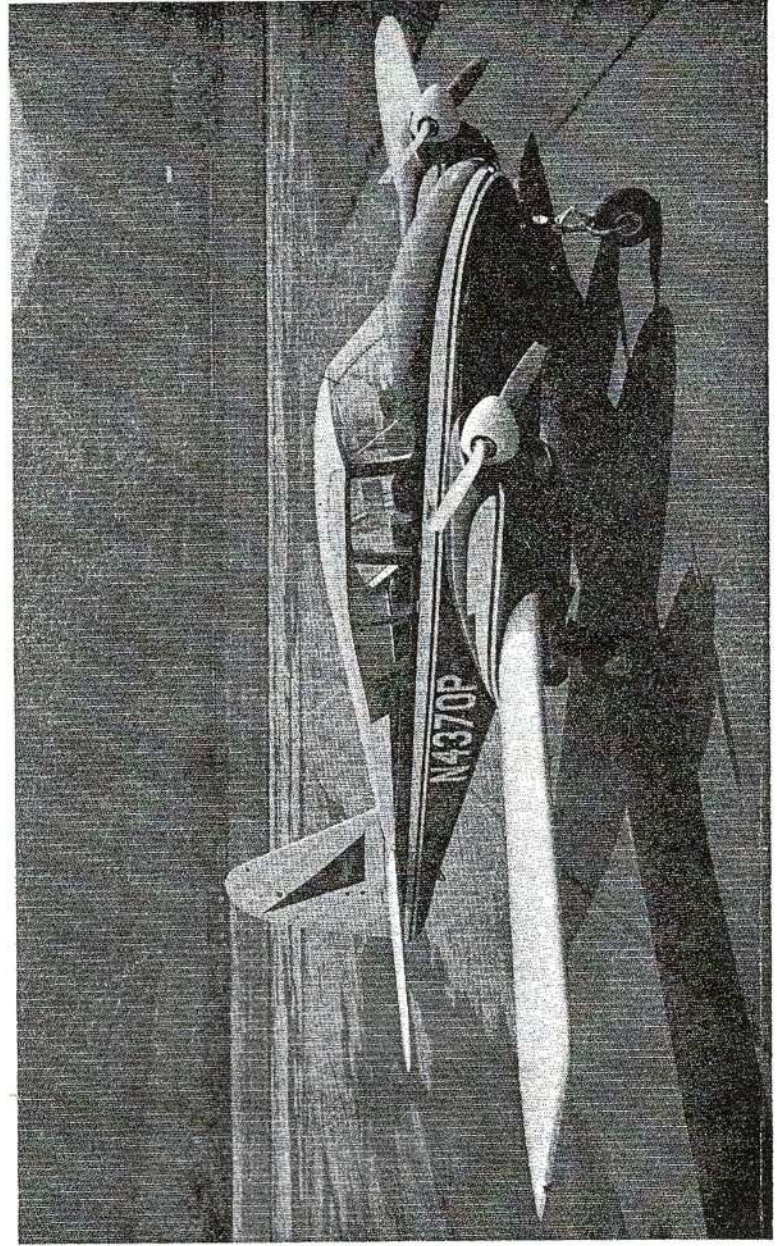

**APACHE
OWNER'S HANDBOOK**



APACHE

PA-23-160 G

Owner's Handbook



**Piper Aircraft Corporation, Lock Haven, Pa.
U. S. A.**

NOTICE

THIS HANDBOOK IS NOT DESIGNED, NOR CAN ANY HANDBOOK SERVE, AS A SUBSTITUTE FOR ADEQUATE AND COMPETENT FLIGHT INSTRUCTION, OR KNOWLEDGE OF THE CURRENT AIRWORTHINESS DIRECTIVES, THE APPLICABLE FEDERAL AIR REGULATIONS, AND ADVISORY CIRCULARS. IT IS NOT INTENDED TO BE A GUIDE OF BASIC FLIGHT INSTRUCTION, NOR A TRAINING MANUAL.

THE HANDBOOK IS DESIGNED:

1. TO HELP YOU OPERATE YOUR APACHE WITH SAFETY AND CONFIDENCE.
2. TO MORE FULLY ACQUAINT YOU WITH THE BASIC PERFORMANCE AND HANDLING CHARACTERISTICS OF THE AIRPLANE.
3. TO MORE FULLY EXPLAIN YOUR APACHE'S OPERATION THAN IS PERMISSIBLE TO SET FORTH IN THE AIRPLANE FLIGHT MANUAL.

IF THERE IS ANY INCONSISTENCY BETWEEN THIS HANDBOOK AND THE AIRPLANE FLIGHT MANUAL APPROVED BY THE F.A.A., THE AIRPLANE FLIGHT MANUAL SHALL GOVERN.

Revised text and illustrations shall be indicated by a black vertical line in the margin opposite the change.

Additional copies of this manual, Part No. 753 574, may be obtained from your Piper Dealer.

Published by
PUBLICATIONS DEPARTMENT
Piper Aircraft Corporation
753 574
Issued: 1961
Revised: April 1973

SECTION ONE

	Page
DESIGN FEATURES	
I. Specifications	5
II. Engines and Propeller	6
III. Fuselage and Wing Structures	7
IV. Landing Gear	9
V. Hydraulic System	11
VI. Control System and Surfaces	15
VII. Fuel System	15
VIII. Electrical System	16
IX. Finish	18
X. Instrument Panel	19
XI. Seats	20
XII. Radio Equipment	20
XIII. Heating and Ventilating	21

DESIGN FEATURES

I. Specifications:

	PA-23-160
	Gross Wt. 3800 Lbs.
Model G	23-1871 and up
Engines	Lyc. O-320-B
HP and RPM	160 at 2700
Empty Wt. (Standard Model) (Lbs.)	2320
Empty Wt. (Auto Flite Model) (Lbs.)	2435
Useful Load (Lbs.) (Standard)	1480
Useful Load (Lbs.) (Auto Flite)	1365
Wing Span (Ft.)	37' 1 3/4"
Wing Area (Sq. Ft.)	207.56
Length (Ft.)	27.1
Height (Ft.)	9.5
Propeller Diameter (Max. In.)	72
Power Loading (Lbs. per HP)	11.9
Wing Loading (Lbs. per Sq. Ft.)	18.6
Baggage Capacity (Max. Lbs.)	200
Baggage Space (Cu. Ft.)	25
Fuel Capacity (Std.-Gals.)	72
Fuel Capacity (Optional-Gals.)	108
Tire Pressure (Lbs.) Nose 27; Main	35
Wheel Base (Ft.)	7.3
Wheel Tread (Ft.)	11.3
Top Speed (MPH)	183
Opt. Cruise Speed, 75%, 6000' (MPH)	171
Cruise Speed 65%, 9000' (MPH)	163
Sea Level Cruise Speed, 75% (MPH)	161
Stall Speed, Power Off, Flaps Down (MPH)	56
Take-off Run (Ft.)	1190
Landing Roll, Flaps Down (Ft.)	750
Best Rate of Climb Speed (MPH)	100
Rate of Climb (Ft. per Min.)	1050
Best Angle of Climb Speed (MPH)	75
Best Single Engine R/C Speed (MPH)	95
Single Engine R/C (Ft. per Min.)	180
Service Ceiling (Ft.)	17,000
Single Engine Absolute Ceiling (Ft.)	5,500
Fuel Consumption (Gal./Hr. at 75%)	18.8
Fuel Consumption (Gal./Hr. at 65%)	16.3
Cruise Range—Max. at 75% at S. L. (Mi.)	940
Cruise Range—Max. at 65% at 9000' (Mi.)	1070
Cruise Range—Optimum (Mi.)	1260
Minimum Controllable Single Engine Speed (MPH)	72

Published figures are for custom airplanes flown at gross weight under standard conditions at sea level unless otherwise stated.

II. Engines and Propellers:

The Lycoming O-320-B engines in the Apache are rated at 160 HP at 2700 RPM. The O-320-B has a compression ratio of 8.5:1 and uses 91/96 octane fuel.

The right engine on the standard Apache is equipped with a vacuum pump, and the left engine with a generator and hydraulic pump. A second vacuum pump and generator are available as optional equipment, or as standard equipment on the Super Custom Apache. Both engines are shielded and equipped with Woodward or Hartzell propeller governor units.

Engine mounts are of steel tubing construction and incorporate vibration absorbing Lord mounts. Engine cowls are largely interchangeable and are cantilever structures attached at the firewall. Side panels are quickly removable by means of quick release fasteners. The nose cowl section is split for quick removal.

The exhaust system is a cross-over type with exhaust gasses directed into muffled jet augments tubes located on the outboard side of each engine. This system provides for exhaust elimination

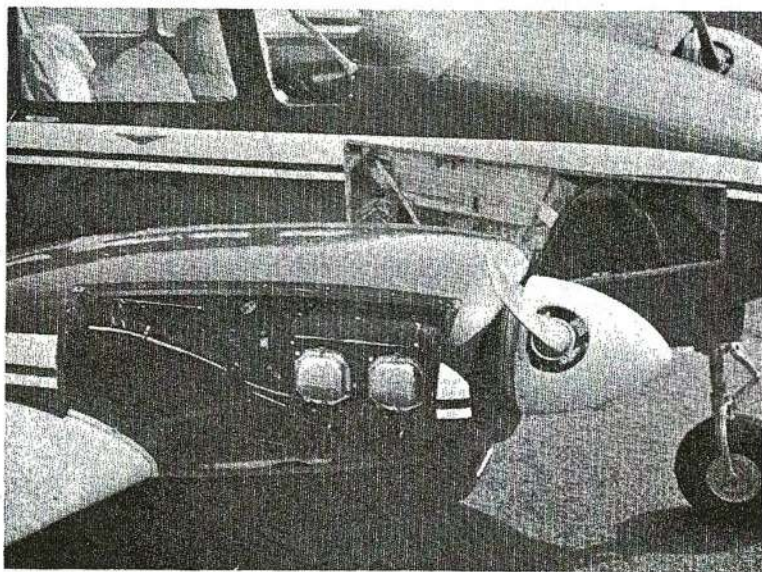

without power loss, and effective engine cooling through the pumping action of the exhaust gasses into the augments tubes, which draws cooling air through the engine compartment; no cowl flaps or cooling flanges are needed on the cowling. Higher aircraft speeds are obtainable with this system due to reduced cooling drag and due to extra thrust furnished by the exhaust augmentation.

Efficient aluminum oil coolers are mounted on the inboard sides of each engine. Engine oil drainage is accomplished with quick oil drain valves located on the right rear corner of the engine crankcases.

Carburetor air is directed through quickly removable filters, located in the nose cowls, to the carburetor air boxes. Heated air for the carburetors is taken from shrouds on the exhaust manifolds through flexible tubes to the air boxes.

The propellers on the Apache are Hartzell HC 82XG-2B or HC-A2XL-2 constant-speed controllable full-feathering units. These are controlled entirely by use of the propeller pitch levers in the center of the control quadrant. Feathering of the propellers is accomplished by moving the controls fully aft through the high pitch detent into the feathering position. Feathering takes place in approximately three seconds. The propellers are unfeathered by moving the prop controls ahead and pressing the starter buttons.

III. Fuselage and Wing Structures:

The Apache fuselage is a composition of four basic units: the sheet metal tail cone, cabin section, nose section, and the steel tubular structure which extends from the tail cone to the nose wheel. The steel tube unit is intended to withstand the high loads imposed on the center section region of the airplane and provides an extra safety factor in this area.

Finish on the tubular unit, as on all steel tube structures in the Apache, is zinc chromate primer with synthetic enamel.

The wing structure is lightweight but rugged, and consists of a massive stepped-down front spar, a rear spar, lateral stringers, longitudinal ribs, stressed skin sheets, and a readily detachable wing tip section. The rectangular plan form of the wing permits the use of many interchangeable parts and simplifies the construction,

while providing for excellent stability and performance characteristics.

The wings are attached to the tubular center section structure with fittings at the sides and in the center of this structure, and the main spars are bolted to each other with high strength butt fittings in the center of the fuselage, making in effect a continuous main spar. This arrangement combines high strength and light weight qualities, since heavy wing hinge fittings on the spars and fuselage are eliminated, as well as an elaborate carry-through structure through the center section of the fuselage.

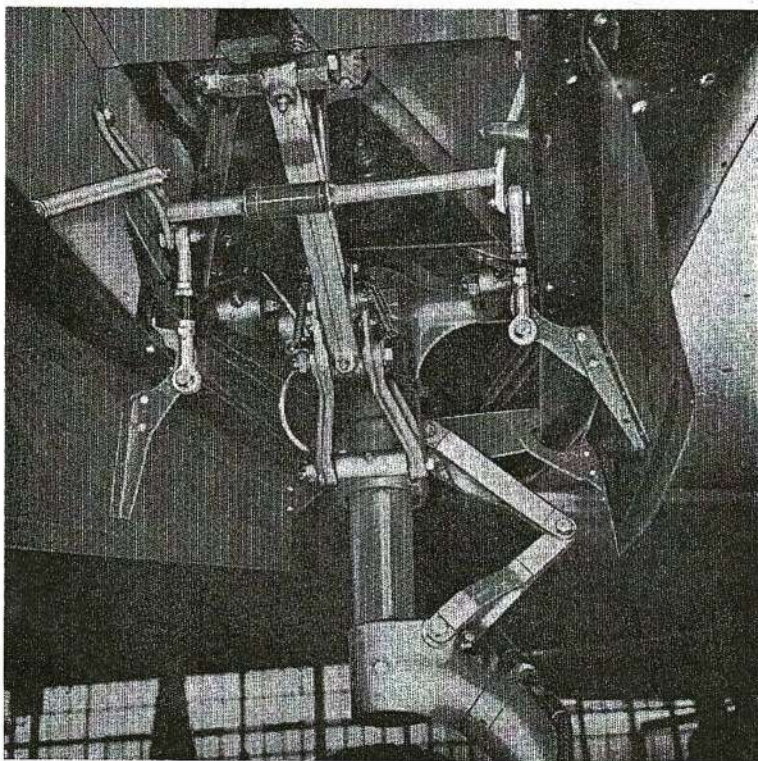

IV. Landing Gear:

All three landing gear units on the Apache incorporate the same soft acting air-oil oleo struts, and contain many directly interchangeable parts.

Main wheels are 600 x 6 Cleveland Aircraft Products units with disc type brakes and 700 x 6 tires with a six ply rating. The nose wheel is a Cleveland 600 x 6 model fitted with a 600 x 6 tire with a four ply rating. All tires have tubes.

Main gear brakes are actuated by toe brake pedals on the

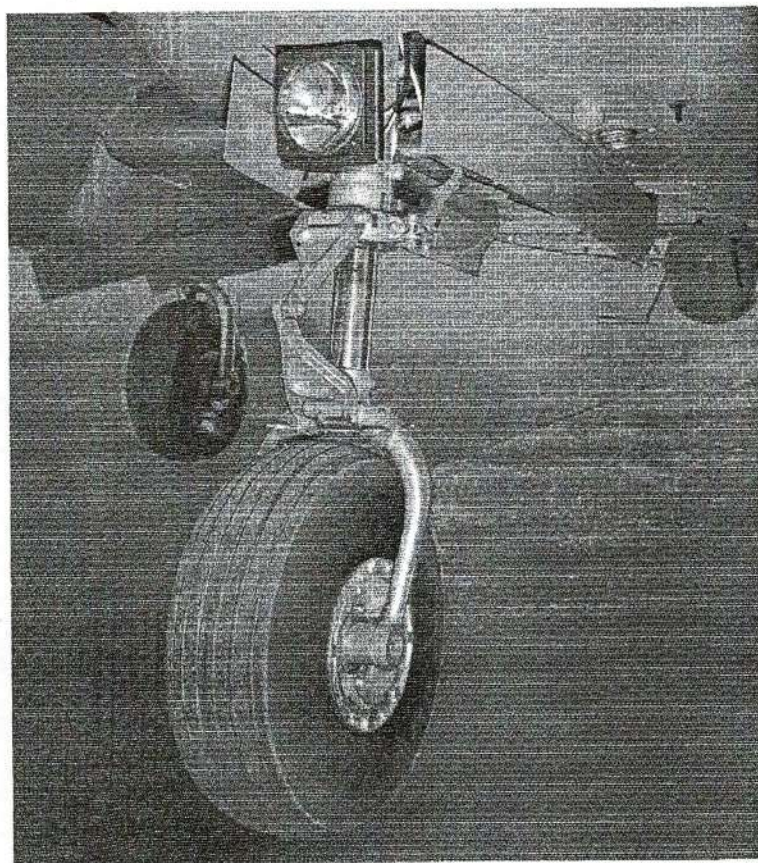

left set of rudder pedals. Hydraulic brake cylinders located in front of the left rudder pedals are readily accessible in the cockpit for servicing. A brake fluid reservoir which is attached to the brake cylinders with flexible lines and provides a reserve of fluid for the brake system, is mounted inside the left nose access panel.

Parking brake valves, operated by a control on the upper left side of the instrument panel, are installed ahead of the forward cabin bulkhead and are also serviced through the left nose access panel.

The nose wheel is steerable through a 30 degree arc through use of the rudder pedals. As the nose gear retracts, the steering

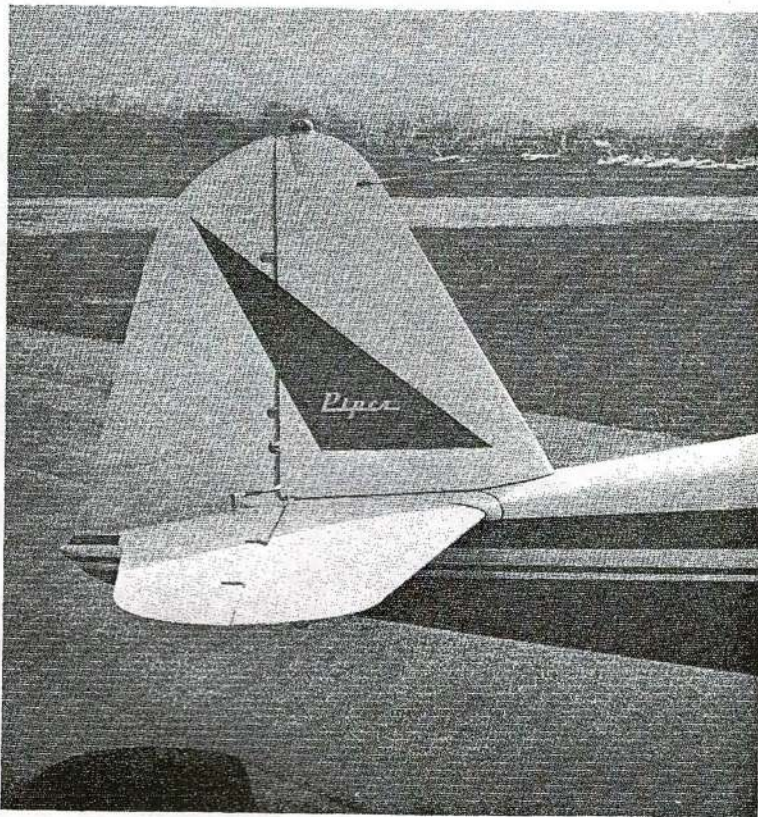

linkage becomes disconnected from the gear so that rudder pedal action with the gear retracted is not impeded by nose gear operation.

The position of the landing gear is indicated by four light bulbs located on the pedestal. When the green lights are on, all three legs of the gear are down and locked; when the amber light is on, the gear is entirely up, and when no light is on, the gear is in an intermediate position.

A red light in the landing gear control knob flashes when the gear is up and either one of the throttles is pulled back. When both throttles are closed beyond a given power setting, (approx. 12" hg. manifold pressure) with wheels not down, the landing gear warning horn sounds.

To guard against inadvertent retraction of the landing gear on the ground, a mechanical latch, which must be operated before the landing gear control can be moved upward, is positioned just above the control lever. The control knob is in the shape of a wheel to differentiate it from the flap control knob which has an airfoil shape. There is also an antiretraction valve located on the left main gear which prevents a build up of hydraulic pressure in the retraction system while the weight of the airplane is resting on its wheels.

V. Hydraulic System:

The hydraulic system is used for the extension and retraction of both the landing gear and flaps. The operation of these units is accomplished by the landing gear and flap selector valve unit which is housed within the control pedestal under the engine controls. Pressure is supplied to the control unit from an engine driven pump mounted on the left engine.

To effect extension or retraction of the gear and flaps, the controls which protrude through the face of the pedestal are moved from the center "Off" in the desired direction. When the selected component is fully extended or retracted, hydraulic pressure within the selector valve unit forces the control back to a neutral or "Off" position, which allows the hydraulic fluid to circulate freely between the pump and the control unit. Also, it isolates the activating cylinders and associated lines from the hydraulic fluid supply. This prevents complete loss of fluid in the event of a leak in the lines between the selector valve and the component or at the actuating cylinders. The return of the control handle to the "Off" position is also a secondary indication that the components have reached full extension or

retraction. The landing gear position lights and the flap indicator should be used as primary indications.

Gear retraction and extension will occur normally in 10 to 12 seconds. The flap operation requires about 4 seconds.

The emergency hydraulic hand pump, which is integral with the selector valve unit, is used to obtain hydraulic pressure in event of failure of the hydraulic pump or the left engine. To operate the emergency pump, the handle should be extended to its full length by pulling aft and positioning the control handle as desired. 30 to 40 pump strokes are required to raise or lower the landing gear.

For emergency extension of the landing gear, if failure of the hydraulic system should occur due to line breakage or selector valve malfunction, an independent CO₂ system is available to extend the landing gear. (See Operating Instructions for details).

Included on the left main gear is an oleo actuated by-pass valve which makes it impossible to retract the landing gear while the weight of the airplane is on the gear. This valve is open when the oleo strut is compressed and by-passes all hydraulic fluid, on the pressure side of the system, to the return side, preventing any pressure build-up in the retraction system. When the oleo strut is extended as in flight, or when the aircraft is on jacks, the valve is closed, permitting the system to operate in the normal manner.

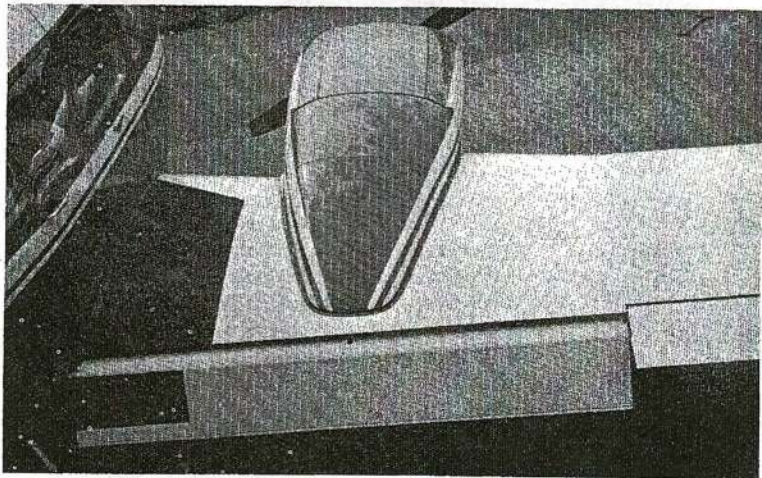

12

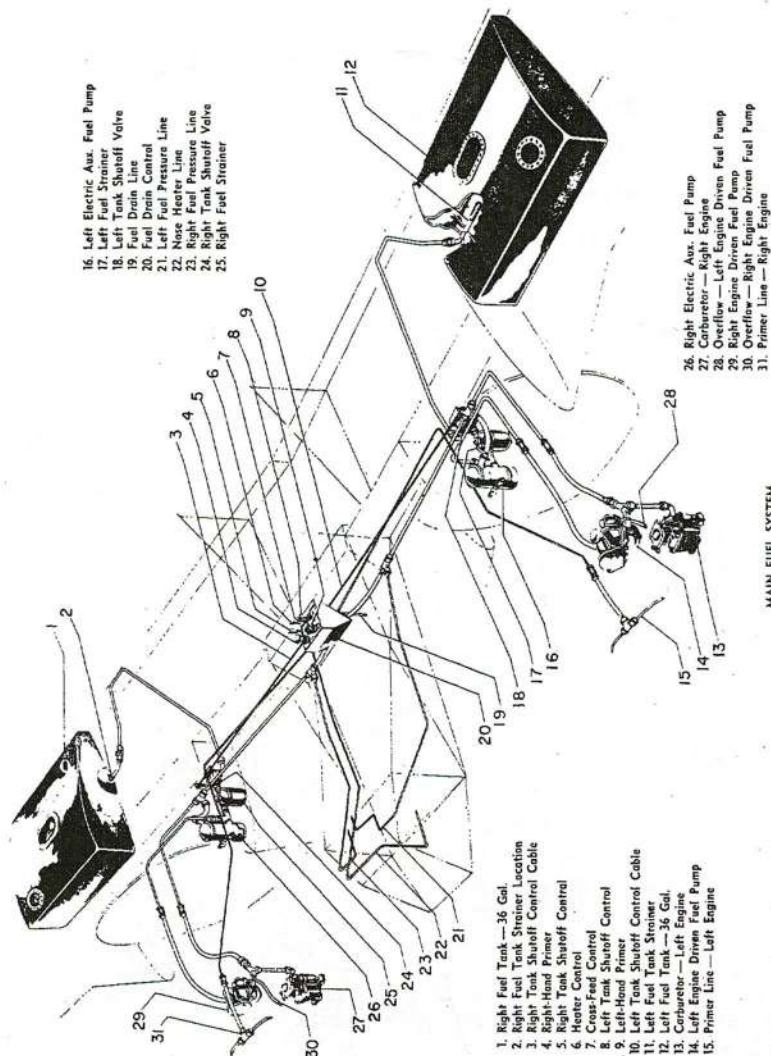

13

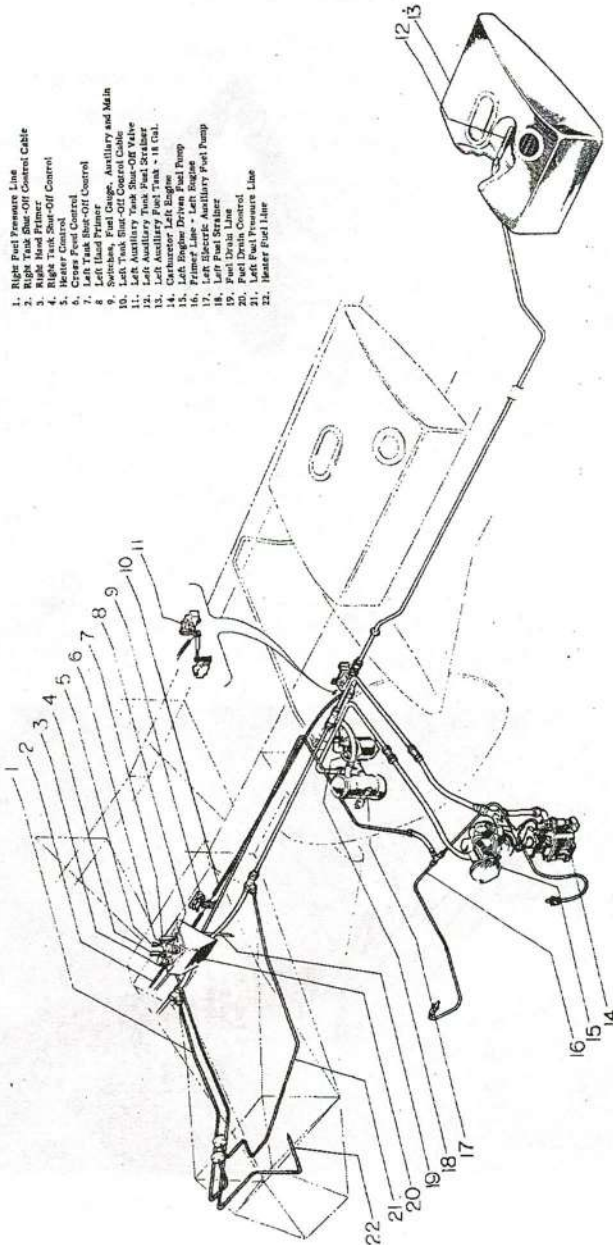

1. Right Fuel Pressure Line
2. Right Tank Shut-Off Control Cable
3. Right Tank Shut-Off Control
4. Bleed Valve
5. Heater Control
6. Cross Feed Control
7. Left Fuel Shut-Off Control
8. Left Fuel Primer
9. Switches, Fuel Gauge, Auxiliary and Main
10. Left Tank Shut-Off Control Cable
11. Left Tank Shut-Off Control
12. Left Auxiliary Tank Fuel Strainer
13. Left Auxiliary Fuel Tank - 18 Gal.
14. Carburetor Left Engine Fuel Pump
15. Carburetor Right Engine Fuel Pump
16. Primer Line - Left Engine
17. Left Electric Auxiliary Fuel Pump
18. Left Fuel Strainer
19. Fuel Drain Control
20. Fuel Drain Control
21. Left Fuel Pressure Line
22. Heater Fuel Line

AUXILIARY FUEL SYSTEM — APACHE
Left Side and Crossfeed Shown

VI. Control System and Surfaces:

Dual wheel and rudder flight controls are provided in the Apache as standard equipment. All controls are light yet solid and effective in flight at all speeds down through the stalling speed. The nose wheel is steerable on the ground through the rudder pedals and the left set of pedals are equipped with toe brakes.

All control surfaces on the Apache are conventional sheet metal structures, fitted with cast hinges and needle bearings. The elevators are actuated by a tubular push-pull system, and the flaps by a hydraulic cylinder located in the right side of the cabin wall. Access to this cylinder is obtained by the removal of the upholstered interior panel immediately ahead of the baggage door.

The ailerons and rudder are connected by cables with the control wheel and rudder pedals. The rudder has a trim tab operated by a crank in the center of the forward cabin ceiling. Longitudinal trim is through bungee springs located back near the elevators and controlled by a larger crank adjacent to the rudder tab control.

VII. Fuel System:

Two thirty-six gallon nylon and neoprene fuel cells located outboard of the engine provide fuel storage in the standard Apache. Auxiliary tanks holding eighteen gallons each are installed optionally in the outboard section of the wing. The tanks should be kept full of fuel during storage of the airplane to prevent accumulation of moisture, and to prevent deterioration of the rubber cells. For long term storage without fuel, the cells should be coated with light engine oil to keep the rubber from drying out.

The fuel system in the Apache is simple, but completely effective. Fuel can be pumped from any tank to both engines, through use of the four fuel pumps provided for this purpose.

For normal operation, fuel is pumped by the engine driven pumps from the tanks directly to the adjacent carburetors. The fuel valves can be left on at all times and the crossfeed left in the off position. Electric auxiliary fuel pumps are installed in by-pass fuel lines between the tanks and the engine driven pumps. The electric pumps can be used to provide pressure in the event of failure of the regular pumps. They are normally turned on to check their operation before starting the engines, and left on during take-off and landing, to preclude the possibility of fuel pressure loss due to pump failure at critical times.

If one of the engine driven pumps fails, the electric pump to

that engine can be turned on to supply the fuel. However, if desired, the fuel can be pumped by the operating engine driven pump to the failed pump engine simply by turning on the crossfeed. The good pump will then be supplying both engines from its tank. If this tank runs low on fuel, fuel can be drawn from the opposite tank by turning on the electric pump on the failed pump side, leaving the crossfeed on, and turning the fuel valve on the empty tank off. Then the electric pump on the failed pump side will be supplying both engines from its tank.

Fuel can thus be used from one tank or the other, by shutting off one main valve and turning on the crossfeed, to balance fuel loads or for other purposes. For all normal operation, it is recommended that fuel be pumped directly from the tanks to their respective engines, with the crossfeed off.

The fuel valve controls and crossfeed control are located with the engine primer pumps in fuel control panel between the front seats. Two electric fuel gauges in the engine gauge cluster on the instrument panel indicate the fuel quantity in each tank. The electric fuel pump switches are on the lower left side of the instrument panel.

A crossfeed line drain valve control is mounted on the front face of the fuel control panel box. This valve should be opened occasionally, with the crossfeed on, to allow any water that might accumulate at that point to be drained out. The heater fuel control is also placed on the fuel control panel, so that fuel to the heater can be turned off if necessary.

The main fuel strainers are located in the inboard sides of the main wheel wells. They are fitted with quick drains and should be drained regularly through their small access ports. Fuel screens are provided at the tank outlets, in the carburetors and in the fuel pumps.

Idle cut-offs are incorporated in the carburetors and should always be used to stop the engines. This is accomplished by pulling the mixture control levers to the rearmost position.

VIII. Electrical System:

The master switch for the electrical system is located on the lower left side of the control pedestal, along with the heating and ventilating control panel. Other electrical switches and circuit breakers are grouped on the lower left side of the instrument panel.

The starter switch is located immediately above the parking

brake handle on the extreme left side of the instrument panel. This switch is spring loaded and locks in the center "Off" position. To operate, pull out on the switch guard and hold to left or right as desired. After starting, release the switch and it will return to the off and locked position.

Automatic circuit breakers are provided for all electrical circuits. These units automatically break the electrical circuit if an overload is applied to the system, preventing damage to the wires. To reset the circuit breakers, simply push in the buttons. Continual popping out of a circuit button indicates trouble in the electrical system and should be investigated immediately. The circuit breakers can be manually tripped by pulling on knobs to isolate or determine the source of electrical trouble.

A 12-volt 33-ampere hour battery, enclosed in a sealed stainless steel battery box, is mounted in the nose section on the right side.

The position and panel lights are operated by a rheostat switch located with the other electrical switches. The position lights are turned on with the first movement of the knob; panel light intensity

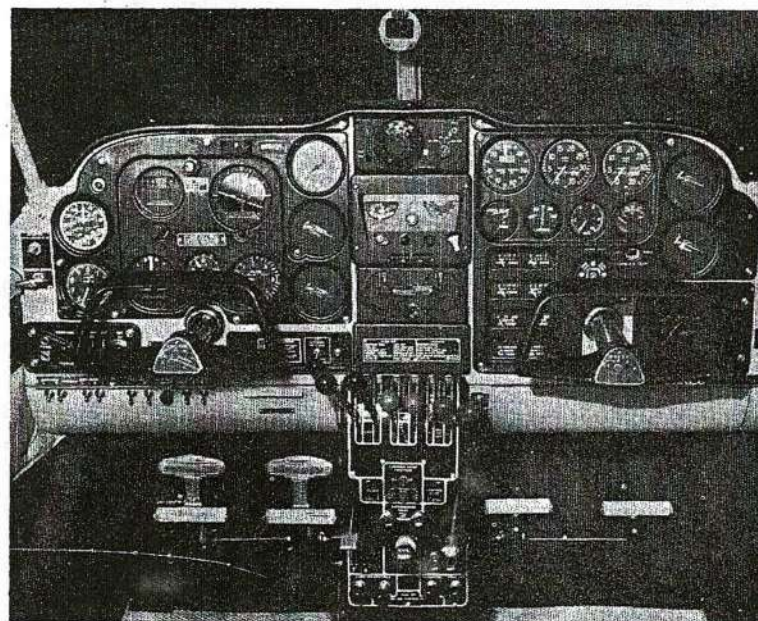

is increased by further rotation of the control. A dome light switch is incorporated in the light unit in the center of the cabin ceiling.

Generator switches are mounted on the lower right side of the pedestal. When dual 50 ampere generators are installed optionally or on the Super Custom Apache, a voltage regulator for each generator is attached to the adjacent firewall. A paralleling relay equally divides the total electrical load between generators. When one engine is stopped a reverse current relay automatically disconnects that generator from the circuit.

IX. Finish:

All aluminum sheet components of the Apache are carefully finished inside and outside to assure maximum service life. Both sides of all pieces are alodine treated, and/or sprayed with zinc chromate primer. External surfaces are coated with durable synthetic enamels in attractive high gloss colors. The application of primer to interior surfaces will prevent corrosion of structural and non-structural parts on the inside where there is no access for normal maintenance.

Steel tubular structures are also finished with zinc chromate primer and enamel.

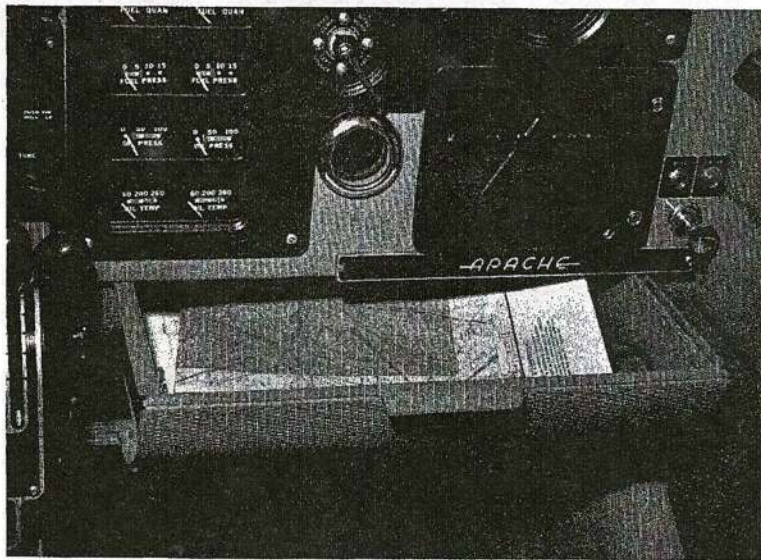

X. Instrument Panel:

The instrument panel of the Apache has been designed to accommodate all of the customary advanced blind flight instruments on the left side in front of the pilot, and all required engine instruments on the right side. Provision for extra instruments has been made in both sections. The flight instrument group is shock mounted in an easily removed sub-panel. All instruments are accessible for maintenance by removing a portion of the fuselage cowl over the instruments.

The Artificial Horizon and Directional Gyro in the flight group are vacuum operated through use of a vacuum pump installed on the right engine. The Turn and Bank is an electrically operated instrument and serves as a standby for the Gyros in case of vacuum system failure. A switch for the Turn and Bank is included in the switch grouping on the lower left of the panel. The vacuum

gauge in the engine instrument group normally indicates $3\frac{3}{4}$ to $4\frac{1}{2}$ inches of suction, required to operate the gyros.

Two recording Tachometers are provided to eliminate the need for constant reference to aircraft and engine log books. An engine instrument cluster, at the bottom of the engine group, includes two oil pressures, two oil temperatures, two fuel pressures, two fuel quantity gauges. The gauges in this cluster can be replaced individually by removing the column of four gauges in which the defective unit is incorporated, then detaching the proper gauge from this column.

Radio units are installed in the center of the main panel. Radio power supplies are mounted in the forward part of the nose section near the battery.

XI. Seats:

All seats in the Apache are constructed of steel tubing, with no-sag springs and foam cushions. The front seats are adjustable fore and aft through a seven inch range by operation of a release control under the front of each seat. The right front seat is also adjustable aft beyond the normal range to provide ease of entry to the pilot's seat. Both front seats are easily removed by taking out the lower bolts in the stop plates at the rear of the seat structure, swinging the stop plates laterally and sliding the seats forward off their tracks.

The rear seat area is equipped with two or three individually adjustable and quickly removable seats. To remove these seats, stop plates on the tracks are taken off, and the seats moved fore or aft as required to disengage from their tracks.

The four standard seats in the Apache are reclining and are provided with head rest attachments and two headrests.

Arm rests for all seats, coat hangers, ash trays, a cigarette lighter, a spacious map drawer and glove compartment are all standard on the Apache. The cabin door and baggage doors are equipped with locks operated by the same key. A tow bar is provided with each airplane and, when not in use, is stowed in the baggage compartment.

XII. Radio Equipment:

In the standard model of the Apache, provisions for radio installations include dual microphone and headset jacks, a microphone and headset mounting bracket, a loud speaker, wiring to these units, and panel space for at least four radio sets.

The Custom model includes the above along with the installation of a group of radio units which are specifically chosen to provide in the Apache all of the most recent radio developments normally desired in this type of aircraft. The Lear ADF-12E gives low frequency range and broadcast bands with a long range Automatic Direction Finder. The Narco Omnigator Mark II with 23 channel VHF transmitter provides Omni navigation and primary VHF communications, and the Narco Mark V with its 90 transmitter frequencies and 190 receiving frequencies gives additional and standby VHF communications.

The Omnigator also incorporates a 75 M.C. Marker Beacon receiving unit, and VAR and ILS runway localizer receiving features.

The Auto Flite model includes the Piper AutoControl, a single axis two control autopilot.

XIII. Heating and Ventilating:

The flow of air for cooling or heating the Apache cabin may be controlled by the four knobs on the cabin air control panel, and by individual overhead outlets. Air is exhausted through an outlet on the rear trim panel of the cabin.

The left hand control regulates air flowing to the front seat through the heater system and the second knob from the left controls air flowing to the rear seat through this system.

The second knob from the right is the defroster control and the right hand control supplies additional cold air to the front seat through a vent on the firewall.

Cabin air enters the heater system through an inlet above the landing light. Air controlled by the righthand knob above is picked up by a scoop below the landing light. An additional scoop on the top of the airplane supplies the air for the overhead outlets.

A 27,500 B. T. U. Southwind heater installed in the nose section of the Apache furnishes a source of hot air for cabin heating and windshield defrosting. Heater operation is controlled by an off-prime-low heat-high heat switch which is located under the left control wheel.

During ground operation or when the landing gear is extended, the ventilating fan motor operates and provides air flow through the heater system. In flight, when the gear is retracted, a micro switch on the nose gear cuts off the heater fan, and heater air is supplied by ram pressure through the nose inlet. This arrangement assures an

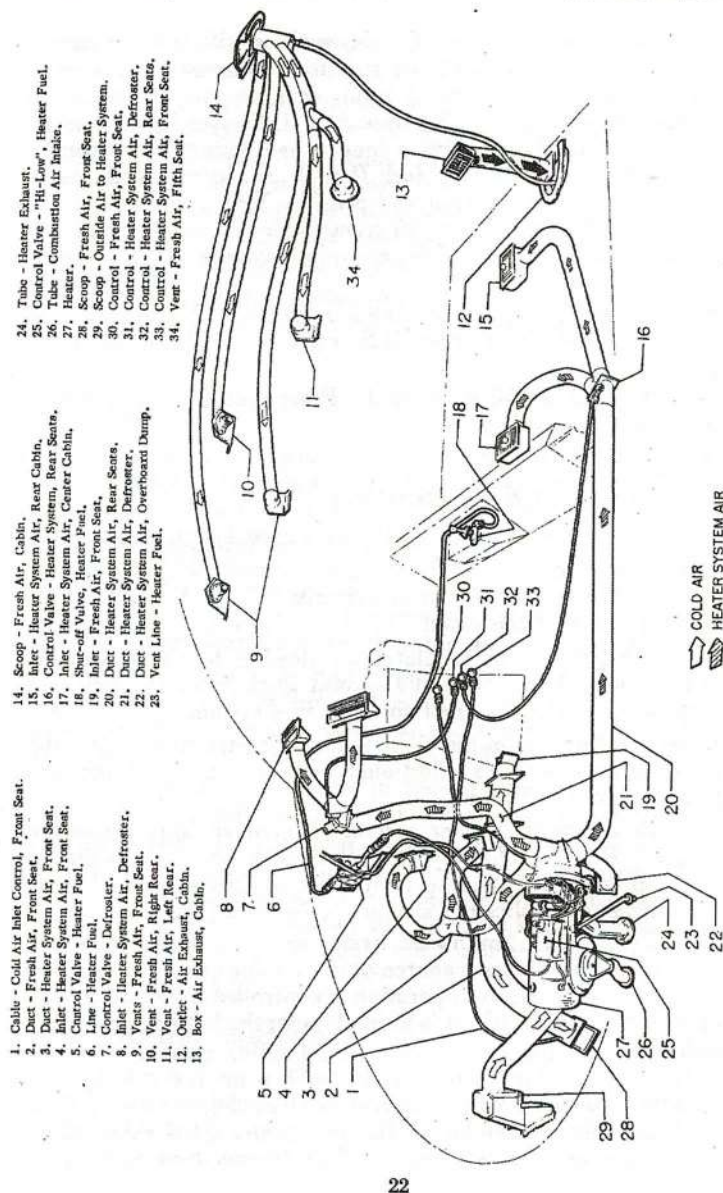

adequate flow of air through the heater at all times, without operating the fan unnecessarily in flight.

To heat the cabin—(1) turn the heater switch to High heat or Low heat as desired, (2) adjust the left hand cabin air control to get the required heat to the front seat, (3) adjust the rear seat control to obtain the required flow to the back of the cabin. The amount of heated air passing to the rear seat area can also be regulated by opening or closing the shutters at the outlets in the floor. Low heat should be used to as low an outside temperature as possible, with the control valves fully opened if necessary; below this temperature, the high heat setting should be used.

Use of the high heat position on the ground may result in excessive exhaust smoke from the heater; therefore, high heat should only be used in flight and the low heat position be used for heating the cabin during ground operation.

The cabin heater uses gasoline from the left main fuel tank when the fuel crossfeed is off, and from both tanks when the crossfeed is on. Only about one quart of gasoline per hour is used by the heater at maximum output.

To turn the heater on, first ascertain that the heater fuel valve (on the fuel control panel) is on, then move the heater switch to High or Low heat. If the heater does not start promptly, return the heater switch to Prime position for 15 seconds to prime the heater; then upon moving the switch to High heat, the heater should start and continue to operate after 1-1½ minutes of warm-up.

After the heater switch is turned to the Off position, combustion in the heater stops, but the combustion fan and the circulating air fan continue to operate for about two minutes, while the heater cools slowly and purges itself of hot air and fumes. To obtain best service life from the heater components, it is recommended that the heater switch be turned off about two minutes before stopping the engines and shutting off the master switch. This should normally be done during taxiing after landing.

The heater can be used to warm up the cabin before flight by turning on the master switch, the left electrical fuel pump, and the heater switch. The operation of these units takes about 8 amps, and they should not be used in such a way as to run down the battery, making starting difficult.

There is a dump valve arrangement in the heater bonnet to exhaust excessive heat thereby making it possible to operate the heater with all controls in the closed position.

SECTION TWO

OPERATING INSTRUCTIONS		Page
I. Preflight		25
II. Starting		26
III. Warm-up and Ground Check		27
IV. Take-off, Climbs, Stalls		29
V. Cruising		30
VI. Approach and Landing		31
VII. Stopping the Engines		32
VIII. Emergency Procedures		32
IX. Ground Handling and Mooring		37
X. Weight and Balance		37
XI. Operation Tips		37

OPERATING INSTRUCTIONS

I. Preflight:

Be sure that you have been thoroughly checked out before operating this aircraft.

The following safety procedure instructions must become an integral part of the aircraft owner's operational routine and/or preflight inspection.

Before each flight, visually inspect the airplane, and/or determine that:

- (1) The tires are satisfactorily inflated and not excessively worn.
- (2) The landing gear oleos and shock struts operate within limits.
- (3) The propellers are free of detrimental nicks.
- (4) The ground area under propeller is free of loose stones, cinders, etc.
- (5) The cowling and inspection opening covers are secure.
- (6) There is no external damage or operational interference to the control surfaces, wings or fuselage.
- (7) The windshield is clean and free of defects.
- (8) There is no snow, ice or frost on the wings or control surfaces.
- (9) The tow-bar and control locks are detached and properly stowed.
- (10) The fuel tanks are full or are at a safe level of proper fuel.
- (11) The fuel tank caps are tight.
- (12) The fuel system vents are open.
- (13) The fuel strainers and fuel lines are free of water and sediment by draining all fuel strainers once a day.
- (14) The fuel tanks and carburetor bowls are free of water and sediment by draining sumps once a week.
- (15) There are no obvious fuel or oil leaks.
- (16) The engine oil is at proper level.
- (17) The brakes are working properly.
- (18) The radio equipment is in order.

(19) The weather is satisfactory for the type of flying you expect to do.

(20) All required papers are in order and in the airplane.

(21) Upon entering the plane, ascertain that all controls operate normally, that the landing gear and other controls are in proper position and that the door is locked.

II. Starting:

Before starting the engine, the pilot should set the parking brake and turn on the master switch and the electric fuel pumps. Each pump should be individually checked for operation. When the engine is cold, (under 40° F.) prime three to five strokes, making sure fuel valves are on, cross-feed off, fuel pressures normal and fuel quantity checked. Push mixture controls to full rich, carburetor heat off, and open throttles about one-quarter inch. If the engines are extremely cold, they should be pulled through by hand four to six times.

Next turn all ignition switches on and engage starter on left engine first. After engine starts, idle at 800 to 1200 RPM and start right engine. If battery is low, before starting right engine, run left engine over 1200 RPM to cut in the generator. This will produce extra power for starting the right engine. If the engine does not start in the first few revolutions, open the throttle on that engine while the engine is turning over with the ignition on. When the engine starts, reduce the throttle.

If the above procedure does not start the engine, reprime and repeat the process. Continue to load cylinders by priming or unload by turning the engine over with the throttle open. If the engine still doesn't start, check for malfunctioning of ignition or fuel system.

Priming can be accomplished by pumping the throttle controls, and excessive pumping may over-prime the engines, making starting difficult.

When the engines are warm, (over 40° F.) do not prime, but turn ignition switches both on before engaging starter. The engines should start after rotating through about four compression strokes.

III. Warm-Up and Ground Check:

As soon as the engines start, the oil pressures should be checked. If no pressure is indicated within thirty seconds, stop the engine and determine the trouble.

Warm-up the engines at 800 to 1200 RPM for not more than two minutes in warm weather, four minutes in cold weather. If electrical power is needed from the generator, the engines can be warmed at 1200 RPM at which point the generator cuts in. The magnetos should be checked at 2000 RPM with 15" HG. MP the drop not to exceed 125 RPM. The engines are warm enough for take-off when the throttles can be opened without engine faltering.

Carburetor heat should be checked during the warm-up to make sure the heat control operation is satisfactory and to clear out the carburetor if any ice has formed. It should also be checked in flight occasionally when outside air temperatures are between 20 degrees

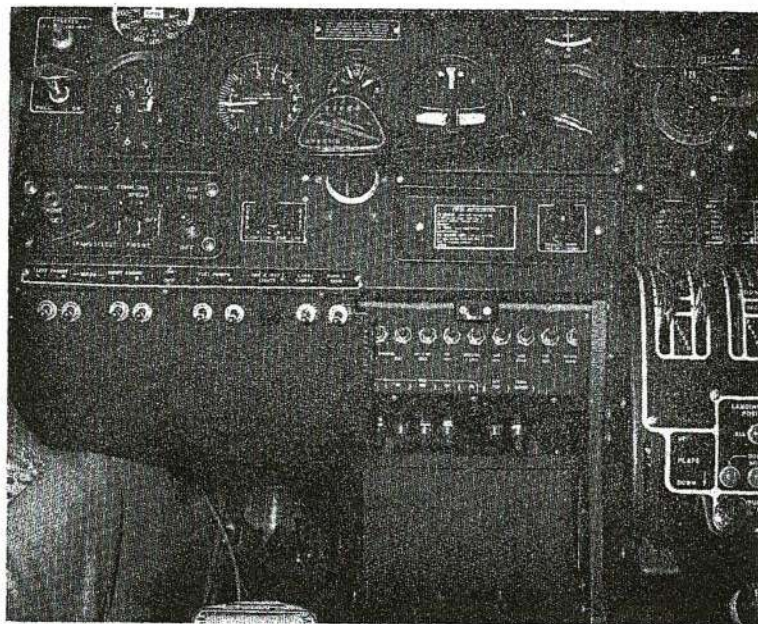

and 70 degrees to see if icing is occurring in the carburetor. In most cases when an engine loses manifold pressure without apparent cause, the use of carburetor heat will correct the condition.

The propeller controls should be moved through their normal ranges during the warm-up to check for proper operation, then left in the full low pitch positions. Full feathering checks on the ground are not recommended, because of the excessive vibration caused in the power plant installations. However, feathering action can be checked by momentarily pulling the propeller controls into the feathering position and allowing the RPM to drop not lower than 1500 RPM, thence returning the controls to a normal operating position.

The electric fuel pumps should be turned off after starting or during warm-up to make sure that the engine driven pumps are operating. Prior to take-off the electric pumps should be turned on again to prevent loss of power during take-off due to fuel pump failure.

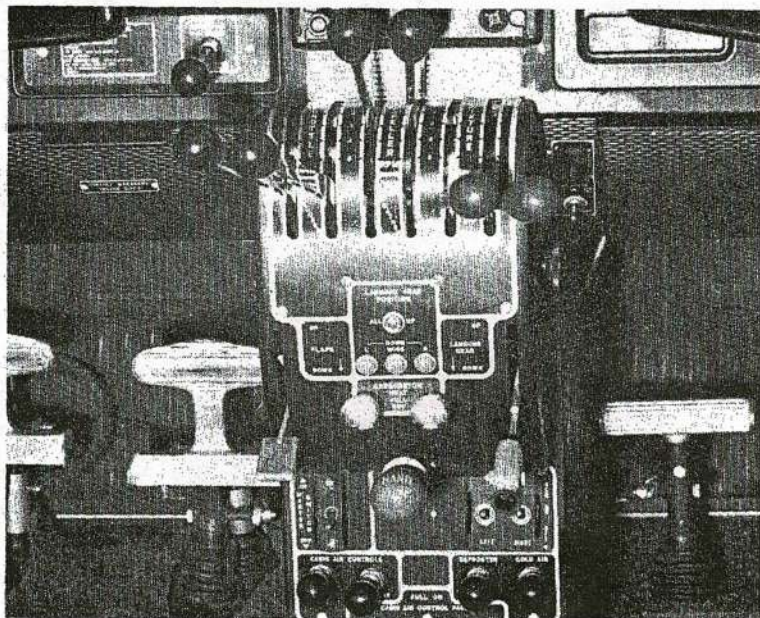

IV. Take-Off, Climbs and Stalls

Just before take-off the following should be checked:

- | | | |
|--------------------|----------------------------|----------------------------|
| (1) Controls Free | (5) Electric Fuel Pumps On | (9) Mixtures Rich |
| (2) Fuel On | (6) Flaps Up | (10) Propellers Set Normal |
| (3) Crossfeed Off | (7) Tabs Set | (11) Engine Gages Normal |
| (4) Primers Locked | (8) Carburetor Heat Off | (12) Door Locked |

After the take-off has proceeded to the point where a landing can no longer be made wheels-down in the event of power failure, the wheels should be retracted. As the wheels come up, the throttle should be brought back to climbing power, 25" MP, and the RPM reduced to 2400. Minimum single engine speed (72 MPH) should be attained as soon as possible. The best rate of climb is obtained at 100 MPH, but to give a high forward speed as well as a good rate of climb, a cruising climb speed of 120 MPH is recommended.

The gross weight power off stalling speed of the Apache is 56 MPH, with full flaps. The stalling speed increases about 5 MPH, with flaps up. All controls are effective at speeds down through the stalling speed, and stalls are gentle and easily controlled.

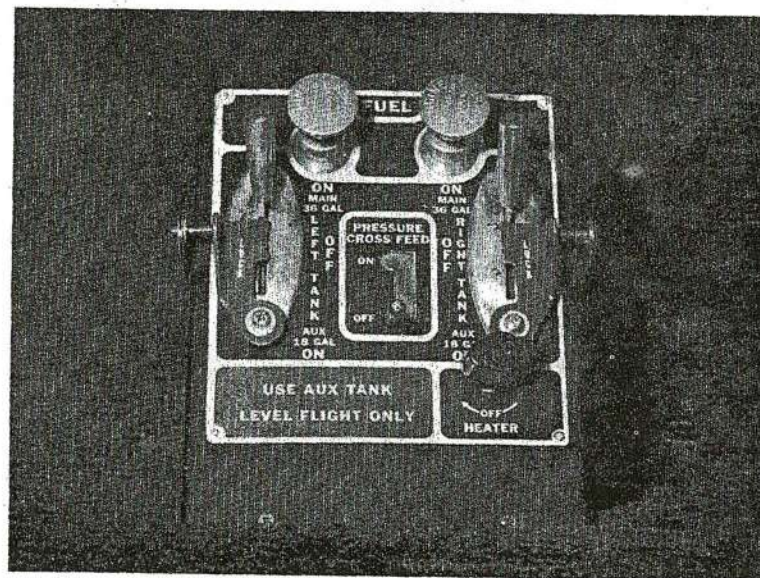

V. Cruising:

The cruising speed of the Apache is determined by many factors including power setting, altitude, temperature, load, and equipment installed on the airplane.

The normal recommended cruising power setting of the Apache is at 65% power. At 9000 feet this gives a True Air Speed of 165 M. P. H. This power setting is obtained under standard conditions at 2400 R. P. M. and 19.2" M. P. Fuel consumption is about 8.15 gallons per hour, or 16.3 gallons per hour total.

The optimum cruising speed of the Apache is 173 M. P. H. for the Custom 160. (See Power and Performance charts for power settings and performance under various conditions).

The Lycoming engines on the Apache can be cruised at any percent of power from 75% down. 2400 RPM is recommended for maximum cruise performance and lower RPM's, down to 1800, for more economical cruising conditions. Ordinarily, an RPM setting should be selected which will give maximum smoothness. To avoid undesirable stresses on the propeller and the possibility of detonation in the engine, no Manifold Pressure settings over 25" should be used with an R. P. M. of less than 2000.

Use of the mixture control in cruising flight reduces fuel consumption at least 10%, according to altitude. The fuel consumption data in this manual is for cruising with the mixture leaned. The engines should be leaned at all times in cruising altitudes over 5000 feet, and during cruising below 5000 feet at the pilot's discretion.

The carburetor heater on the Apache is of extremely high capacity, and is designed to provide enough heat to remove carburetor icing and related induction system phenomena under the most severe conditions. A heat rise of approximately 200°F can be obtained with the application of full heat. This creates a power loss of about 20% with very little indication on the Manifold Pressure gauge, which has a maximum drop of about 1/2 inch M. P. The power loss will show up in the performance of the airplane, and should be held to a minimum by applying only that amount of heat required to keep the carburetor or induction system free of ice.

Locking controls on the carburetor heaters and carburetor Air Temperature gauges are provided to facilitate setting and maintaining the carburetor air temperatures at the proper level for positive de-icing without excessive power loss. Due to the two stage action of the carburetor heat box control, a slight retarding action will be

noticed when pulling the carburetor heat control on at about the three quarter open position; however, a slight pull will allow the control to continue to full carburetor heat.

The application of carburetor heat enriches the mixture, and frequently may require resetting the mixture control for smooth and economical engine operation.

VI. Approach and Landing:

During the approach the gear can be lowered at speeds under 150 MPH, preferably on the downwind leg. Flaps should be lowered in final approach at an airspeed under 125 MPH, and the airplane trimmed to a gliding speed of 90 MPH. Normally about 12" MP should be maintained to give a reasonable approach angle. RPM

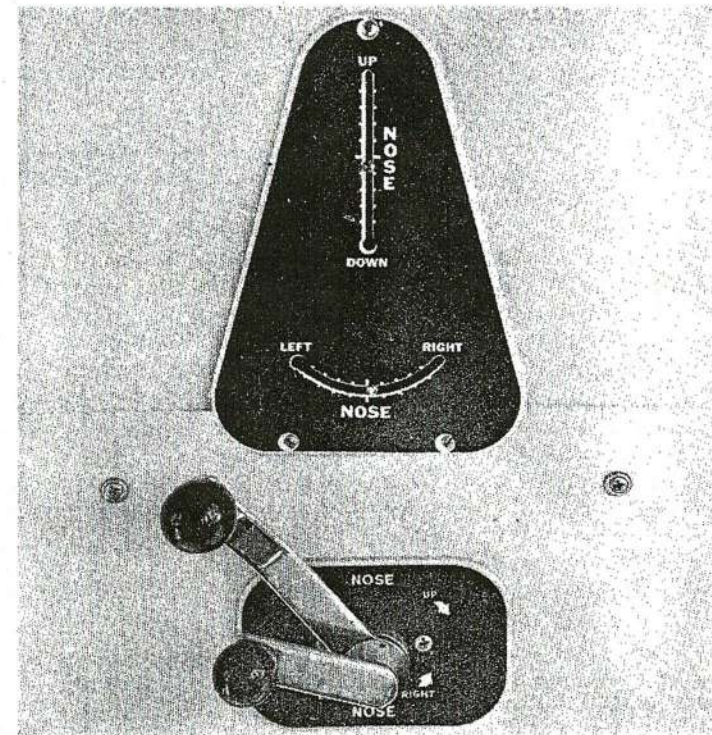

should be left at high cruising RPM or approximately 2400. This propeller setting gives ample power for an emergency go-around and will prevent overspeeding of the engines if the throttle is advanced sharply.

The amount of flap used during landings and the speed of the airplane at contact should be varied according to the wind, the landing surface, and other factors. It is always best to contact the ground at the minimum practicable speed consistent with landing conditions.

Normally, the best technique for short and slow landings is to use full flap and a small amount of power, holding the nose up as long as possible before and after ground contact. In high wind conditions, particularly in strong crosswinds, it may be desirable to approach the ground at higher than normal speeds, with half or no flaps.

Landing Check List:

- (1) Mixtures rich.
- (2) Propellers at high cruising R. P. M.
- (3) Carburetor heat off (unless icing conditions exist).
- (4) Electric fuel pumps on.
- (5) Fuel on proper tanks.
- (6) Landing gear down (under 150 M. P. H.), check green indicator lights on, landing gear warning horn off, and flashing red light in gear handle off.
- (7) Flaps full down or as desired (under 125 M. P. H.).

If for any reason, it becomes necessary to "go around" apply full power, put the flaps up and retract the landing gear as quickly as possible.

VII. Stopping the Engines:

During the landing roll, the flaps should be raised, the heater turned off, and the electric fuel pumps off. After parking, the radios should be turned off, and the engines stopped by pulling the mixture controls aft to idle cut-off. The throttle should be left full aft to avoid engine vibration while stopping. Then the ignition and master switches should be turned off, and the parking brakes set.

VIII. Emergency Procedures:

1. ENGINE FAILURE:

An engine failure on the Apache during cruising flight presents very minor operational problems. As the engine loses power, a slight yaw in the direction of the dead engine will occur, which can be corrected easily with the rudder or the rudder trim tab. While

the plane is slowing down to the single engine cruising speed of about 110 MPH at low altitudes and at moderate power settings, the propeller on the dead engine should be feathered by pulling the throttle to idling position, and the prop pitch control back fully; then the mixture should be set at idle cut-off, and the ignition off. Best single engine performance will be obtained with the dead engine wing held up about 3 degrees higher than level to help counteract the tendency to turn in that direction.

If the left engine has failed, the generator and hydraulic pump will not be functioning. Enough power will remain in a well-charged battery to operate the electrical equipment in the airplane for a considerable period, but conservation of the battery power by turning off all unneeded equipment should be practiced. If it is necessary to lower the landing gear or flaps with the left engine dead, the hydraulic hand pump located in the pedestal is used.

If the right engine fails, the vacuum pump will no longer function, and the Directional Gyro and Artificial Horizon will not operate. The electric Turn and Bank will then be used for instrument flight.

2. FEATHERING:

The Hartzell feathering propellers can only be feathered while the failed engine is rotating, and not if the engine stops completely, because the centrifugal force due to rotation is necessary to hold out a stop-pin which keeps the propeller from feathering each time the engine is stopped on the ground. Therefore, if an engine freezes up, it will not be possible to feather its propeller. In that case, single engine flight can be maintained with the dead engine propeller unfeathered, although a noticeable decrease in single engine performance will take place.

If an engine failure occurs during the take-off run, the power on the good engine should be cut and the airplane stopped straight ahead. If it occurs after leaving the ground, but with sufficient landing area still ahead, a landing should be effected immediately. If no landing can be made directly after the failure, the following steps should be followed:

- (1). Apply full power to good engine.
- (2). Feather dead engine.
- (3). Retract landing gear and flaps, if extended (using hand pump if left engine is out). If enough altitude has been

reached before the failure occurred, or if performance is satisfactory for reaching the airport with the gear extended, leave the landing gear in the down position.

- (4). Maintain a best climb airspeed of 95 MPH, 80 MPH minimum.
- (5). Trim directionally with rudder trim.
- (6). As the airport is reapproached for the landing, reduce power on the good engine and gradually retrim with the rudder tab. When it is obvious that the airport can be reached easily, lower the landing gear and check the indicators to make sure it is down and locked. Maintain a little extra altitude and speed during the approach, keeping in mind that the landing should be made right the first time, and that either undershooting or overshooting may require the use of full power on the good engine, making control more difficult. Lower the flaps at the last moment before landing.

3. UNFEATHERING:

It is not recommended that propeller feathering and unfeathering be practiced on the ground because of the excessive vibration that occurs in the engine installation. In flight, feathering should be practiced only to familiarize the pilot with the proper procedures. To unfeather a propeller in flight, the following technique is recommended:

- (1) Ignition switches on.
- (2) Mixture rich.
- (3) Throttle $\frac{1}{8}$ th open.
- (4) Prop control at cruise setting.
- (5) Engage starter until engine starts.
- (6) Allow engine to idle out of feather, then adjust engine controls for a slow warm up if the engine is very cold. Adjust to cruising power when engine is warm.

The Standard Apache, operating at gross weight under optimum condition of turbulence and pilot technique, and under standard conditions of temperature and altitude, has a single engine absolute ceiling of 5500 feet at 3800 lbs. gross weight and maximum obtainable power.

Under ideal conditions, the Apache can be expected to maintain approximately the stated maximum altitudes. When adverse

conditions of turbulence, temperature, altitude, pilot technique, or aircraft condition or equipment are encountered, the absolute ceiling altitude will be reduced. These factors must be taken into consideration in the single engine operation of any twin engine aircraft.

Pilots of this airplane should remain reasonably proficient in single engine flight. In many cases, "simulated" single engine operation (zero thrust condition, approximately 12" MP and 2300 RPM) will be preferable, but actual single engine operation should be practiced occasionally. The following precautions should be exercised in actual single engine flight:

- (1) Do not feather a propeller if you have reason to suspect that the starting characteristics of the engine are not normal and that restarting in the air may be difficult or impossible.
- (2) Do not feather a propeller in conditions of temperature, altitude weight or turbulence which may prevent single engine flight at altitudes well above the local ground elevation.
- (3) Do not feather a propeller at any time when conditions of terrain or other conditions may prevent the aircraft from reaching an airport easily, in case the dead engine cannot be restarted.
- (4) Single engine operation must be practiced only with a well qualified twin engine rated pilot, familiar with Apache characteristics and procedures, in one of the pilot seats.

4. EMERGENCY LANDINGS:

The Apache is designed to take gear-up emergency landings without extensive damage to the structure of the airplane. All three wheels protrude about one-third of their diameter when retracted, and structure is provided to take minor loads in this condition. On a wheels-up landing, since the main wheels are forward of their down position, the airplane will tend to settle down at the rear when the landing speed is decreasing, and full forward control wheel pressure should be used to hold the tail up as long as possible. The flaps should not be extended because they will contact the ground first, causing damage to the flap and the wing.

A wheels-up landing should only be made during an emergency when the surface is too soft or too rough to permit a gear-down landing, or when an emergency water landing is necessary.

5. EMERGENCY LANDING GEAR EXTENSION:

If the engine driven hydraulic pump fails, or the left engine driving the pump, extension of the landing gear or flaps is accomplished by supplying hydraulic pressure with the manual hydraulic pump. With the gear or flap control in the desired position, 30-40 strokes of the pump handle will raise or lower the landing gear, and 12 strokes will raise or extend the flaps.

In the event of hydraulic system failure caused by a line breaking or the selector valve malfunctioning, the landing gear can be lowered by using the Emergency Gear Extender. The control for the Extender is located beneath a small cover plate under the pilot's seat. When this control is pulled, CO₂ flows from a cylinder under the floorboards through separate lines to shuttle valves adjacent to the gear extension cylinders. The gas pressure opens the shuttle valves, allowing CO₂ to enter the gear cylinders, extending the gears.

The landing gear control on the selector valve must be in the *down* position when the gear extender control is pulled, in order to allow the gear to be extended properly.

The Emergency Gear Extender should only be used when all other means of lowering the landing gear have failed, and only when the gear can be left down for landing. When the Extender has been used, the landing gear must not be retracted or actuated hydraulically in any way until the extension system has been returned to its normal condition.

6. IN-FLIGHT CABIN DOOR CLOSING PROCEDURE

In the event the cabin door is inadvertently unlocked in flight or should the handle not be pushed forward to its full locked position before take-off and becomes dislodged from its latching mechanism, the following procedure has been determined to be practicable for closing the cabin door while in flight, assuming adequate altitude has been attained.

- (1) Retard throttle
- (2) Reduce airspeed to 90 MPH or less
- (3) Open storm window (left of pilot)
- (4) Close door
- (5) Recover power and airspeed

Other conditions, take-off, landing approach, and general low altitude flight, will require the discretion of the pilot.

IX. Ground Handling and Mooring:

The Apache should be moved on the ground with the aid of the nose wheel steering bar provided with each plane and installed in the baggage compartment.

Tie down ropes for mooring the airplane can be fastened to the wing tie down rings and at the tail skid.

The aileron and elevator controls should be secured by means of the safety belt or control locks to prevent control surface damage. The rudder is held in position by its connections with the steerable nose wheel, and does not need to be secured except under unusually high wind conditions.

X. Weight and Balance:

For weight and balance data, see the Weight and Balance Form supplied with each airplane, which gives the exact weight of the airplane and permissible center of gravity conditions.

XI. Operation Tips:

In the operation of the Apache, as in that of any other type of aircraft, there are a few points of technique and information that apply particularly to this model. The following Operating Tips may be helpful in the operation of the Apache:

(1) Learn to trim the airplane for take-off so that only a very light back pressure on the wheel is required to lift the ship off the ground.

(2) Due to the very rapid feathering action of the propeller on the Apache, it will be necessary when feathering during ground check to move the propeller control in and out of feather position very quickly in order to prevent the RPM from dropping below 1500 RPM and causing excessive manifold pressure.

(3) On take-off, do not retract the gear prematurely. The aircraft may settle and make contact with the ground because of lack of flying speed, atmospheric conditions or rolling terrain.

(4) The best speed for take-off is at about 80 MPH under normal conditions. Trying to pull the airplane off the ground at too low an airspeed decreases the controllability of the airplane in the event of engine failure. (Minimum controllable single engine airspeed is 72 MPH.)

II SECTION

The Piper Apache

- (5) Before attempting to reset any circuit breaker, allow a two to five minute cooling off period.
- (6) Always ascertain position of landing gear by checking the gear position light.
- (7) For convenience and to obtain best service life from the heater components, it is recommended that the heater switch be turned off about two minutes before stopping the engines and shutting off the master switch. This should normally be done during taxiing after landing.
- (8) Remember that when the navigation lights are on the gear position lights are very dim.
- (9) Before starting the engines ascertain that all radio switches, light switches, and pitot heat switch are in the off position, so as not to create an overloaded condition when the starter is engaged.
- (10) If plane vibrates after becoming airborne before landing gear retraction, check for a worn spot on one of the tires.
- (11) In high density areas where high traffic speeds are necessary or when it is advantageous to extend the gear, it is permissible to extend the landing gear at speeds up to 150 MPH; however, it is recommended the landing gear should be extended at speeds below 150 MPH.
- (12) The flaps may be lowered at speeds up to 125 MPH. To reduce flap operating loads, however, it is desirable to have the airplane at a slower speed before extending the flaps.

SECTION THREE

	Page
PERFORMANCE CHARTS	39-41
POWER CHART	42

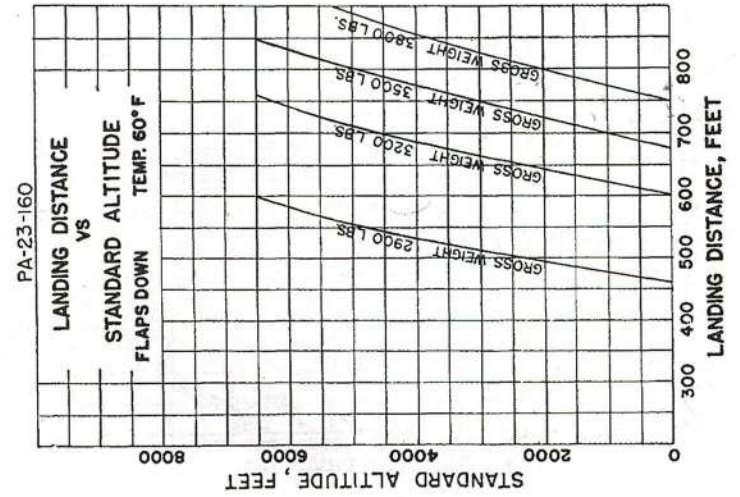
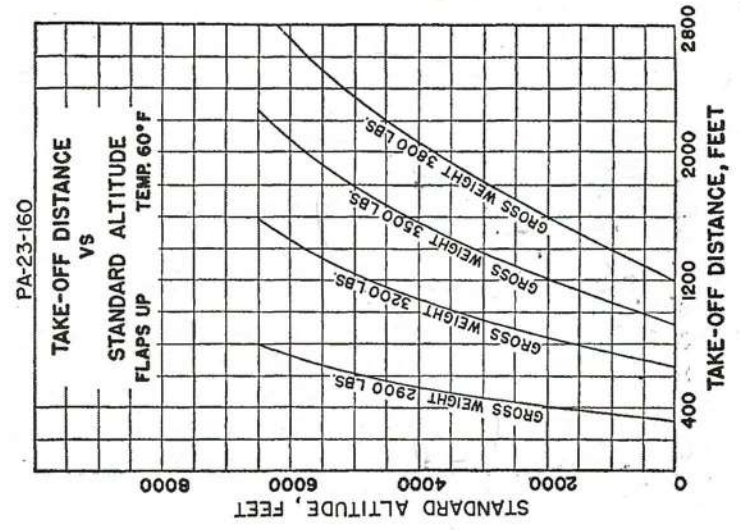

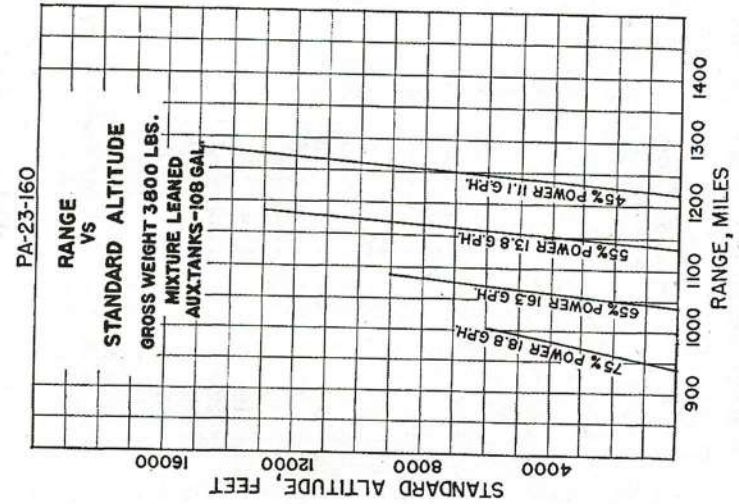
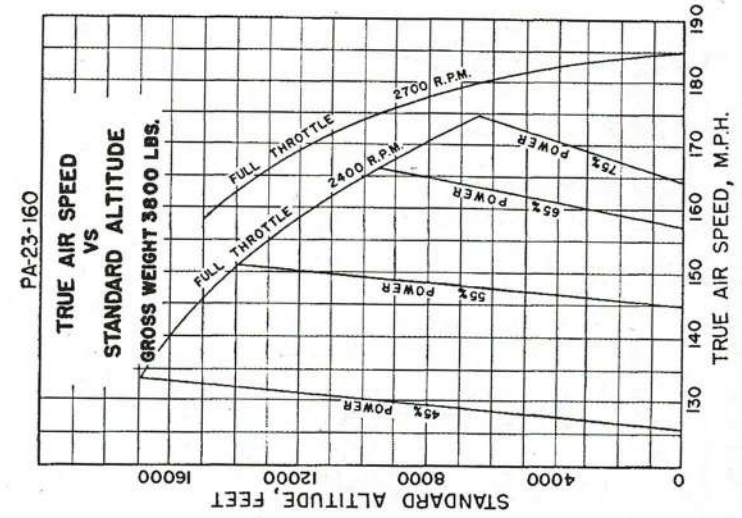
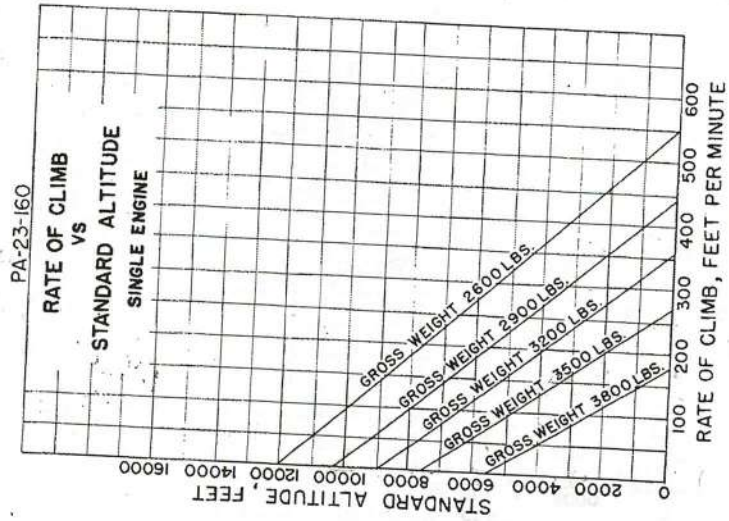
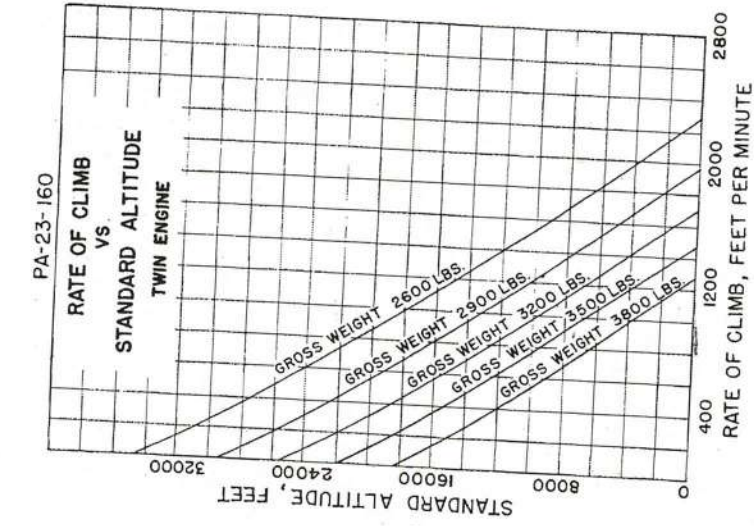

Power Setting Table—Lycoming Model O-320-B, 160 HP Engine

Press. Alt. 1000 Feet	Std. Alt. Temp. °F	88 HP—55% Rated Approx. Fuel 7 Gal./Hr. RPM & MAN. PRESS.		104 HP—65% Rated Approx. Fuel 8 Gal./Hr. RPM & MAN. PRESS.		120 HP—75% Rated Approx. Fuel 9 Gal./Hr. RPM & MAN. PRESS.						
		2100	2200	2300	2400	2100	2200	2300	2400			
SL	59	22.0	21.3	20.6	19.8	24.4	23.6	22.8	22.1	25.9	25.2	24.3
1	55	21.7	20.0	20.3	19.6	24.1	23.3	22.5	21.8	25.6	24.9	24.0
2	52	21.4	20.7	20.1	19.3	23.8	23.0	22.3	21.5	25.0	24.3	23.5
3	48	21.1	20.5	19.8	19.1	23.5	22.7	22.0	21.2	25.3	24.6	23.8
4	45	20.8	20.2	19.6	18.9	23.1	22.4	21.7	21.0	24.7	24.0	23.2
5	41	20.5	19.9	19.3	18.6	22.8	22.1	21.4	20.7	FT	23.7	23.0
6	38	20.2	19.6	19.0	18.4	22.5	21.8	21.2	20.5	FT	FT	22.7
7	34	19.9	19.3	18.8	18.2	22.2	21.5	20.9	20.2	FT	FT	FT
8	31	19.5	19.0	18.5	18.0	22.2	21.2	20.6	19.9	FT	FT	FT
9	27	19.2	18.8	18.3	17.7	FT	FT	20.3	19.4	FT	FT	FT
10	23	18.9	18.5	18.0	17.5	FT	FT	FT	FT	FT	FT	FT
11	19	18.6	18.2	17.8	17.3	FT	FT	FT	FT	FT	FT	FT
12	16	18.3	17.9	17.5	17.0	FT	FT	FT	FT	FT	FT	FT
13	12	FT	17.6	17.3	16.8	FT	FT	FT	FT	FT	FT	FT
14	9	FT	FT	17.0	16.6	FT	FT	FT	FT	FT	FT	FT
15	5	FT	FT	FT	16.3	FT	FT	FT	FT	FT	FT	FT

To maintain constant power, correct manifold pressure approximately 0.15" Hg for each 10° F. variation in carburetor air temperature from standard altitude temperature. Add manifold pressure for air temperatures above standard; subtract for temperatures below standard.

Power Chart, Lycoming O-320-B

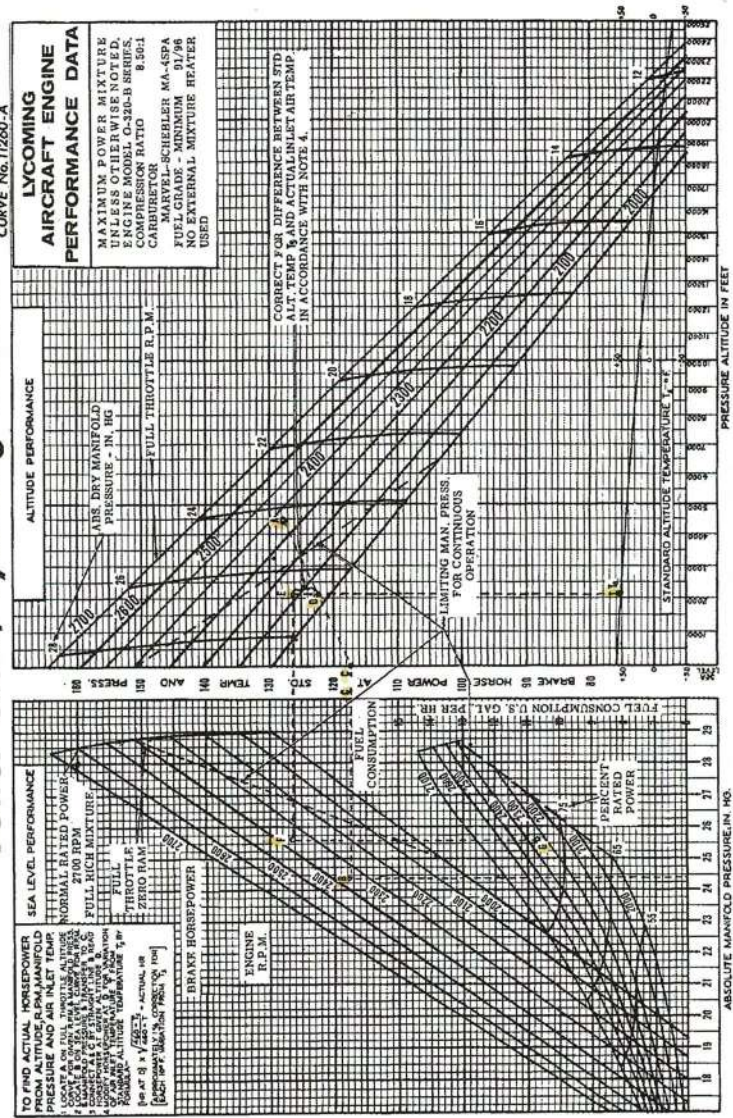

$$\frac{80 \text{ mi/hr} \times 5280 \text{ ft/mi}}{3600 \text{ sec/hr}} = 117 \text{ ft/sec}$$

352 ft
1.46

SECTION FOUR

GENERAL MAINTENANCE	Page
I. Leveling and Rigging	45
II. Tire Inflation	46
III. Battery Service	46
IV. Brake Service	46
V. Landing Gear Service	49
VI. Hydraulic System Service	54
VII. Fuel Requirements	54
VIII. Care of Air Filter	55
IX. Care of Windshield and Windows	55
X. Serial Number Plate	56
XI. Warranty	57

GENERAL MAINTENANCE

I. Leveling and Rigging:

Leveling the Apache for purposes of reweighing or rigging is accomplished as follows:

- (1) Partially withdraw the two machine screws located on the side of the fuselage under the right stabilizer. These screws are leveling points, and the airplane is longitudinally level when a level placed on the heads of the screws indicates level.
- (2) Put the airplane on jacks to obtain the longitudinally level position.
- (3) To level the airplane laterally, place a bubble-protractor on a straight-edge held along the front spar on the under surface of the wing. Raise or lower the wing by pushing up or down on the tip until five degrees of dihedral is indicated on the protractor. The smooth, easy action of the landing gear oleo units makes it possible to position the wing laterally with very little effort. After checking the first wing at five degrees dihedral, the opposite wing should also be checked to make sure it has equal dihedral.

RIGGING INSTRUCTIONS:

Although the fixed flight surfaces on the Apache obviously cannot be adjusted in position for rigging purposes, it may be necessary on occasion to check the positions of these surfaces. The movable control surfaces, with the exception of the flaps, all have adjustable stops, as well as adjustments on their cables or push-pull connections, so that their range of movement can be altered. The positions and travels of the various surfaces are as follows:

- (1) Wings: 5° dihedral, washout 1° in 70" of distance along the front spar. (Total washout approximately 2°).
- (2) Stabilizer: No dihedral—both stabilizer main spars should have identical relationship to horizontal. Incidence is 1° up in relation to horizontal.
- (3) Fin: Should be vertical and in line with centerline of fuselage.
- (4) Ailerons: Travel—30° up, 15° down.
- (5) Flaps: Travel—50° down.

(6) Elevators: Travel—20° up, 15° down.

(7) Rudder: Travel—30° left and right.

For the purposes of adjusting the lateral trim on the Apache, aileron tabs are incorporated on both ailerons. These tabs can be bent to position the aileron in flight, changing the lateral trim as desired.

II. Tire Inflation:

For maximum service from the tires, keep the Apache main wheels inflated to 35 lbs. and the nose wheel to 27 lbs. Reverse the tires on the wheels, if necessary, to produce even wear. All Apache wheels and tires are balanced before original installation, and the relationship of tire, tube and wheel should be maintained upon reinstallation. Out-of-balance wheels can cause extreme vibration in the landing gear during take-off and landing. In the installation of new components, it may be necessary to rebalance the wheels with the tires mounted.

III. Battery Service:

Access to the 12-volt, 33-ampere hour battery is obtained by removing a quickly detachable access plate on the right side of the nose section. The battery is installed in a sealed stainless steel box, opened by removing wing nuts. The box has a plastic drain tube which is normally closed off with a clamp and which should be opened occasionally to drain off any accumulation of liquid.

The battery should be checked frequently for proper fluid level, but must not be filled above the baffle plates. All connections must be clean and tight.

If the battery is not up to proper charge, recharge starting with a charging rate of 4 amps and finishing with 2 amps. Quick charges are not recommended.

IV. Brake Service:

The brake system is filled with Mil-O-5606 (petroleum base) hydraulic brake fluid. This should be checked at every 100 hours inspection and replenished when necessary.

Do not use vegetable base brake fluids when refilling the system.

When it is necessary to add fluid, open the left nose access panel, exposing the brake reservoir. Then add fluid to the reservoir, bringing the fluid to the indicated level.

If it is necessary to bleed the brake system to get air out of the lines, fluid should be added under pressure at the bleeder attachment on the brake unit.

No adjustment of brake clearances is necessary on the Apache brakes. If after extended service, braking action requires too much movement of the toe pedal, new brake linings can easily be installed by removing the four bolts which attach the brake units, then replacing the brake linings held in place by brass rivets.

Main wheels are quickly removed by first cutting the safety wire and removing four bolts to drop the brake lining. Remove the dust cover, cotter pin and axle nut. The wheel will slip off the axle. The nose wheel is removed by taking off the hub nut and withdrawing the axle bolt, the axle retainer cups, and the axle from the nose wheel fork.

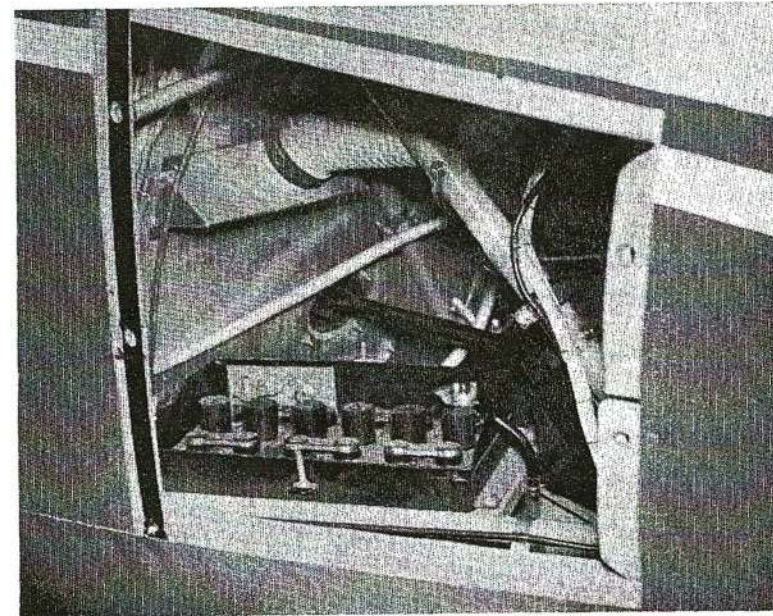

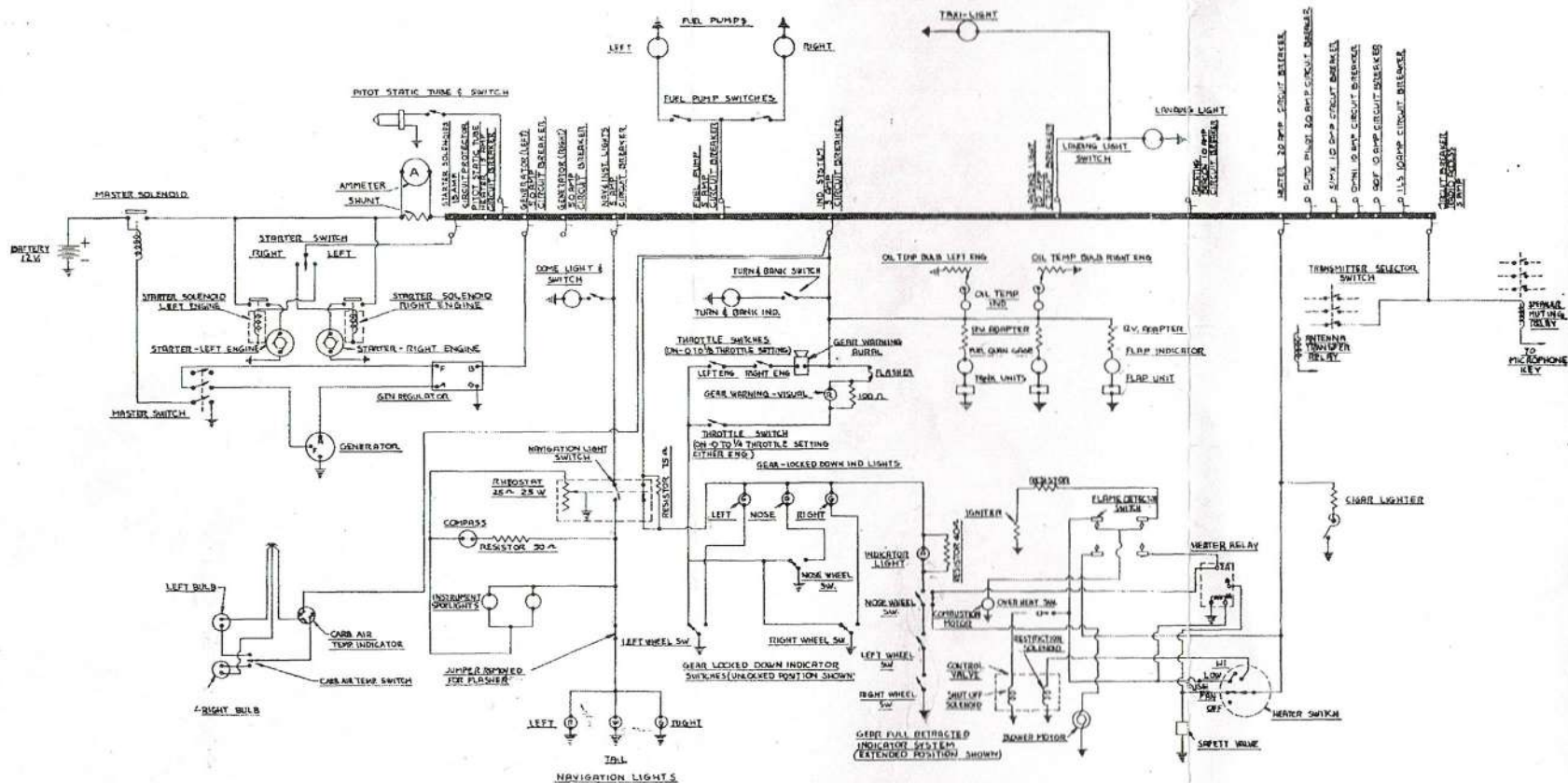

ELECTRICAL SYSTEM APACHE

IV SECTION
The Piper Apache
**ELECTRICAL LOAD ANALYSIS
(PA-23-160)**
**A. MAXIMUM PROBABLE CONTINUOUS LOAD
(less radio equipment)**

ITEM	NUMBER USED PER PA-23	TOTAL CURRENT IN AMPERES PA-23			
		12.0 Volts	14.3 Volts		
Flap Gauge	1				
Fuel Gauge	2				
Oil Temperature Gauge	2	Total:			
Carb. Temperature Gauge	1			.5	.6
L. G. Indicating Lights	1	.08	.1		
Master Contactor	1	.6	.7		
Navigation Lights	3	Total:			
Instrument Lights	2			4.6	5.5
Compass Lights	1				
Turn and Bank	1	.9	1.1		
Heater (operating)	1	5.7	6.8		
Pitot (operating)	1	10.9	13.0		
Rotating Beacon (Grimes)	1	5.0	5.9		

B. INTERMITTENT LOADS

Dome Lights	1	.5	.6
Landing Lights	2	24.5	29.0
Fuel Pumps	2	.8	.9
Landing Gear Horn	1	.7	.8
Starter Solenoids	2	10.0 ea.	
Cigar Lighter	1	6.6	7.9

Tires are dismantled from the wheels by deflating the tube, then removing the wheel through-bolts, allowing the wheel halves to be separated. In reassembling the wheels, care should be taken to torque the nuts properly, according to instructions on the wheels.

V. Landing Gear Service:

In jacking the Apache up for landing gear and other service, the Apache Jack Kit (available through the Piper Distributor Service Department) should be used. This kit includes two hydraulic jacks and a tail support; the jacks are placed under the jack pads on the front wing spar, and the tail support attached to the tail skid.

Approximately 250 lbs. of ballast should be placed on the base of the tail support to hold the tail down. Then the jacks should be raised until all three wheels are clear of the floor.

The right and left landing gear units on the Apache are completely interchangeable by reversing the nutcracker units on the gears. The oleo unit on the nose wheel gear contains parts that are also entirely interchangeable with the oleo parts on the main gears, although the oleo housing forging and the fork and axle are different

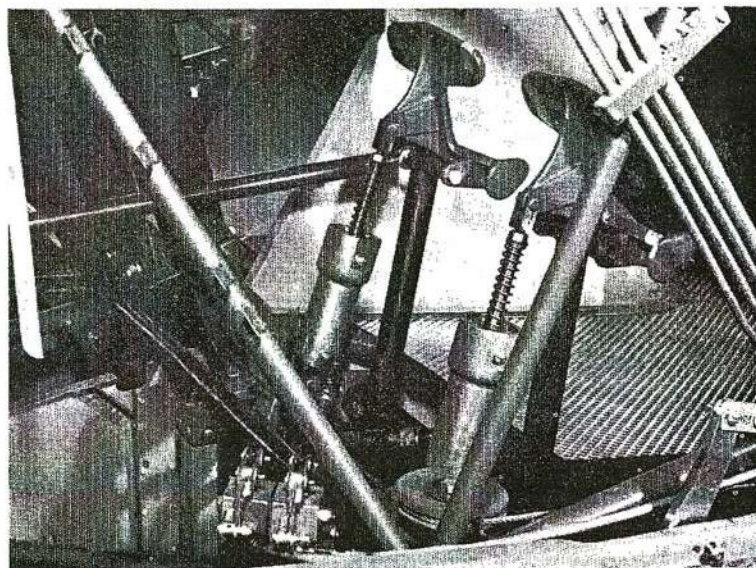

on the nose wheel unit. The nutcracker parts and all inside components are identical on both nose and main gears.

The operation of the landing gear oleos is standard for the air-oil type; hydraulic fluid passing through an orifice serves as the major shock absorber while air compressed statically acts as a taxiing spring. The piston tube has a total travel of 8", and about 3" of tube should be exposed under normal static loads.

All of the oleos are inflated through readily accessible valves on the top of the unit, at the front. The nose wheel unit is steerable through the rudder pedals, and incorporates a shimmy dampening device at the bottom of the outer housing. All major attachment and actuation bearings are equipped with grease fittings for lubrication of the bearing surfaces, and should be lubricated periodically with medium lubricating grease.

To add air to the oleo struts, a strut pump is attached at the air valve and the oleo pumped up until 3" of piston tube is exposed with normal static weight on the gears. To add oil, first release all the air through the valves, allowing the oleo to compress fully. Next remove the air valve core and fill the unit through this opening, extending the strut by rocking the airplane while adding fluid. Compress the oleo again to within $\frac{1}{4}$ " of full compression, allowing excess oil to overflow and working out any trapped air. Then reinsert the valve core and pump up the strut.

If a landing gear oleo has been completely emptied of oil during servicing, the following procedure should be used to refill it, to make sure that no air remains trapped in the unit. First, a clear plastic tube should be attached to the valve stem, from which the core has been removed. The other end of the tube should be placed in a container of hydraulic fluid. When the oleo is extended, fluid will be sucked into the oleo cylinder. The oleo should be compressed and extended until it is full of fluid and no more air bubbles appear in the plastic tube. About one pint of fluid is required to fill the oleo.

To check shimmy of the nose wheel, if it should develop, tighten the bolt on the dampening device at the base of the nose wheel forging. The bolt should be tightened just enough to keep the nose wheel from moving freely, but not enough to require excessive pressure to move the wheel by hand. It may be necessary to remove shims from the shimmy dampening collar to permit tightening of the device.

The steering arms from the rudder pedals to the nose wheel steering torque shaft arm are adjusted at the rudder pedals or at the

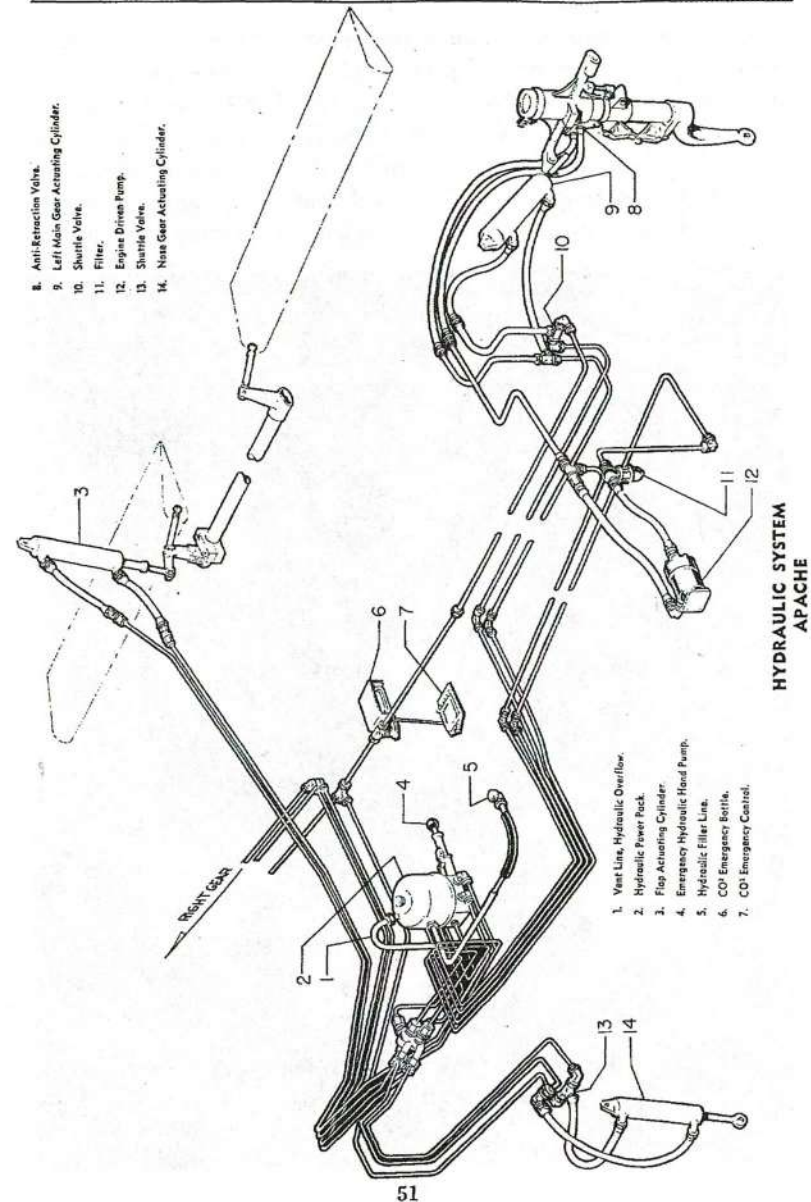

torque shaft rollers by turning in or out the threaded rod end bearings. Adjustment is normally accomplished at the forward end of the rods, and should be done in such a way that the nose wheel is in line with the fore and aft axis of the plane when the rudder pedals and rudder are centered. Alignment of the nose wheel can be checked by pushing the airplane back and forth with the rudder centered to determine that the plane follows a perfectly straight line.

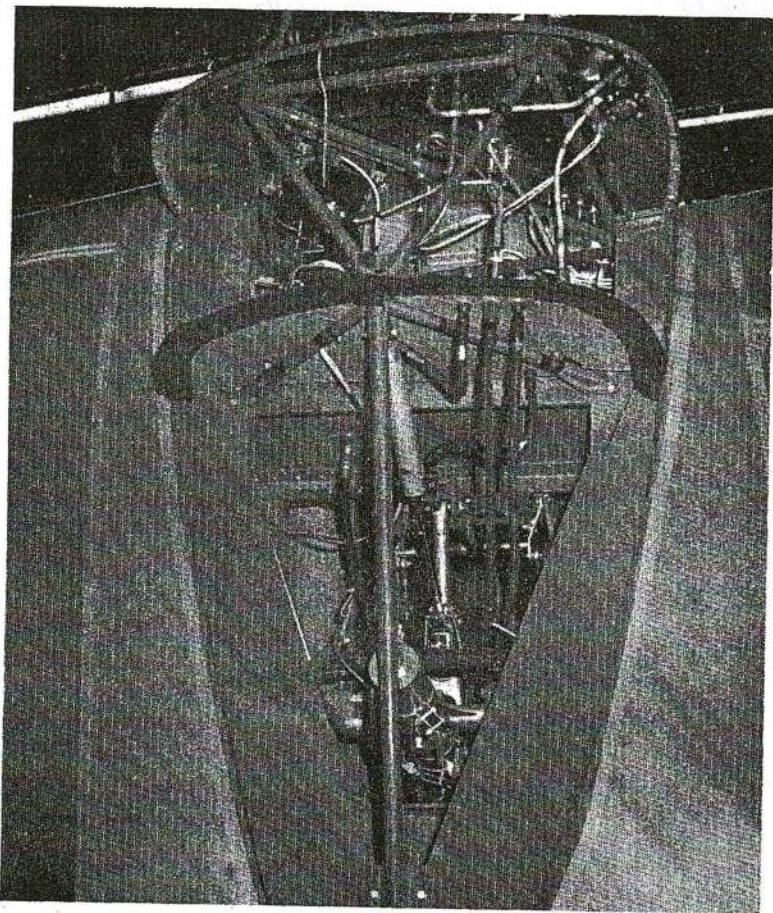

The turning arc of the nose wheel is 15 degrees in either direction and is factory adjusted at stops on the bottom of the forging.

In adjusting the steering arm stops, care should be taken to see that the nose wheel reaches its full travel just after the rudder hits its stops. This guarantees that the rudder will be allowed to move through its full travel.

Adjustable rod end bearings are present on each of the hydraulic cylinders that actuate the landing gear legs. These rod ends should be set so that the cylinders move the landing gear retracting links just far enough to engage the spring loaded down locks and make contact at the stops. Too much extension of the adjusting screws will overload the links, and too little extension will prevent the links from going to the required past-center position.

At each of the landing gear legs, micro-switches are installed so as to close after full movement of the gear in either direction. The down switches are connected individually with green indicator lights on the pedestal, and the up switches are in series so that all three contacts must be made before the amber "gear up" light on the pedestal lights up. The micro-switches must be adjusted carefully so that contact is made just as the gear reaches the required position of extension or retraction.

Other micro-switches on the landing gear warning system are installed inside the control pedestal at the throttles. The warning horn is also located here, and the landing gear knob flasher unit is attached to the left side of the pedestal forward of the instrument panel.

The main landing gear legs are dismantled from the airplane by (1) removing the top engine nacelles, (2) detaching the lower end of the lever retracting link from the gear leg, (3) detaching the brake line at the lower end of the flexible line, and (4) withdrawing the half-inch landing gear attachment bolts.

The nose gear unit is dismantled by (1) removing the nose access panels and the canvas boot covering the top of the nose gear, (2) detaching the lower retracting link, and (3) extracting the landing gear bolts.

Disassembling of the landing gear oleos is done as follows:

- (1) Release air from air valve at top of unit and remove core.
- (2) Detach lower end of oleo torque link assembly (nut-cracker) from fork.
- (3) Remove snap ring, located inside and at bottom of forging, with small-nosed pliers.

- (4) Slide piston tube and bearing assemblies out of forging. Oleo fluid will flow from the forging and much of it can be caught in a container and reused.
- (5) Remove the upper bearing retainer pins and slide both upper and lower bearings from the strut. The "O" rings and wiper strips are then exposed for inspection.

To reassemble the oleo unit, reverse the above procedure, being very careful to see that the snap ring and the upper bearing retainer pins are properly reinstalled.

In the event that the oleo strut slowly loses pressure and extension, the most probable source of trouble is the air valve attachment to the leg, or the core of the air valve. These parts should be checked first to determine whether or not air leaks are occurring. If hydraulic fluid is evident on the exposed chrome-plated oleo strut, the "O" rings on the piston tube bearing units may need to be replaced.

VI. Hydraulic System Service:

The hydraulic system is filled through a filler tube located inside the left nose access panel. Only petroleum base hydraulic fluid, Mil-O-5606, should be used.

To add fluid to the system, remove the cap from the filler neck and fill the system completely while holding the filler tube extension level. Then turn the elbow on the filler tube down until the excess oil has drained out. (See separate instructions for filling and cleaning the complete hydraulic system).

VII. Fuel Requirements:

Aviation grade 91/96 (minimum) octane should be used in the Apache. The use of lower grades of fuel can cause serious engine damage in a very short period of time, and is considered of such importance that the engine warranty is invalidated by such use.

The oil capacity of the Lycoming O-320-B is 8 quarts. It is recommended that engine oil be changed every 50 flying hours, sooner under unfavorable conditions. The minimum safe quantity of oil

required is 2 quarts. The following grades are required for the specified temperatures:

Temperatures above 40°F	-----	S. A. E. 50
Temperatures from 10°F to 40°F	-----	S. A. E. 30
Temperatures below 10°F	-----	S. A. E. 20

VIII. Care of Air Filter:

The carburetor air filters must be cleaned at least once every fifty hours and depending on the type of condition existing, it may be necessary to clean the filters daily or every five hours. Extra filters are inexpensive and should be kept on hand and used for rapid replacement.

The following cleaning and reoiling procedure is recommended by the manufacturer of the filter.

- (1) Remove filter from carburetor air box.
- (2) Wash thoroughly, soiled face down in cleaning fluid and allow to dry. (Cleaning fluid may be gasoline, kerosene, or naphtha.)
- (3) Immerse filter in mixture of three parts oil, specification MIL-L-6082, grade 1100 SAE 60 and one part corrosion preventative compound, specification AN-VV-C-576, and allow to drain for two to four hours. (SAE 50 may be used in lieu of grade SAE 60.)
- (4) Wipe off excess oil and reassemble to carburetor air box.

IX. Care of Windshield and Windows:

The windshield and windows are made of plexiglas and a certain amount of care is required to keep them clean and clear. The following procedure is suggested:

- (1) Flush with clean water and dislodge excess dirt, mud, etc., with your hand.
- (2) Wash with mild soap and warm water. Use a soft cloth or sponge. (Do not rub).
- (3) Remove oil, grease or sealing compounds with a cloth soaked in kerosene.

NOTE: Do not use gasoline, alcohol, benzene, carbon tetrachloride, lacquer, thinner, or window cleaning sprays.

- (4) After cleaning, apply a thin coat of hard polishing wax. Rub lightly with a soft dry cloth.
- (5) A severe scratch or mar can be removed by using jewelers rouge to rub out scratch, smooth on both sides and apply wax.

X. Serial Number Plate:

The serial number plate on the Apache is located on the top of the tail stinger, underneath the rudder. The serial number of the plane should always be used in referring to the airplane in service or warranty matters.

Apache Modification Aircraft Corp.
1893 Airport Road
Kalispell, Montana 59901

Supplement 1

FAA APPROVED
AIRPLANE FLIGHT MANUAL SUPPLEMENT
FOR
PIPER PA-23 AND PA-23-160
WITH
INSTALLATION OF LYCOMING 0-360-A1D ENGINE AND HARTZELL PROPELLER
HC-C2YK-2RB/7666A-2 OR HC-C2YK-2CUF/FC7666A-2

REGISTRATION NO. N2018P
SERIAL NO. 23-590

This Supplement must be attached to the applicable FAA Approved Airplane Flight Manual when Lycoming 0-360-A1D engines are installed in accordance with STC No. SA899SW. The information contained herein, supplements the information of the basic airplane flight manual; for limitations, procedures and performance data not contained in this document, consult the manual proper.

I. LIMITATIONS

Engine: Lycoming 0-360-A1D
Engine Limits (All Operations): 2700 RPM 180 HP
Fuel: 91/96 Octane Minimum
Propeller: Hartzell HC-C2YK-2RB/7666A-2 or HC-C2YK-2CUF/FC7666A-2
Pitch Settings: (30" Station) Low 14.5 Degrees High 80 Degrees (feathered)

Powerplant Instruments:

Oil Temperature	Red Line (Max)	245 Degrees F
	Green Arc	160 to 245 Degrees F
Tachometer	Red Line	2700 RPM
	Red Arc	2000 to 2250 RPM
Fuel Pressure	Green Arc	.5 PSI to 8 PSI
	Red Line	8 PSI

Placard: AVOID CONTINUOUS OPERATION BETWEEN 2000 AND 2250 RPM

Airspeed Limits (CAS) : Minimum Control Speed 75 MPH

II. PROCEDURES - No Change.

III. PERFORMANCE

Performance is equal to or better than that given for the unmodified Models PA-23 And PA-23-160.

FAA APPROVED

Mike Pasion, Manager
Special Certification Branch
Seattle Aircraft Certification Office
Federal Aviation Administration
1601 Lind Avenue S.W.
Renton, WA 98055

DATE

Feb 24, 1999

FAA APPROVED
 AIRPLANE FLIGHT MANUAL SUPPLEMENT
 FOR
 PIPER PA-23
 WITH
 INSTALLATION OF LYCOMING 0-360-A1D ENGINE AND HARTZELL PROPELLER
 HC-C2YK-2RB/7666A-2 OR HC-C2YK-2CUF/FC7666A-2

REGISTRATION NO. N2018P
 SERIAL NO. 23-590

This Supplement must be attached to the applicable FAA Approved Airplane Flight Manual when Lycoming 0-360-A1D engines and dorsal fin with square tail are installed in accordance with STC Nos. SA899SW and SA671SW respectively.* The information contained herein, supplements the information of the basic airplane flight manual; for limitations, procedures and performance data not contained in this document, consult the manual proper.

I. LIMITATIONS

Engine: Lycoming 0-360-A1D
 Engine Limits (All Operations): 2700 RPM 180 HP
 Fuel: 91/96 Octane Minimum
 Propeller: Hartzell HC-C2YK-2RB/7666A-2 or HC-C2YK-2CUF/FC7666A-2
 Pitch Settings: (30" Station) Low 14.5 Degrees High 80 Degrees (feathered)
 Powerplant Instruments:

Oil Temperature	Red Line (Max)	245 Degrees F
	Green Arc	160 to 245 Degrees F
Tachometer	Red Line	2700 RPM
	Red Arc	2000 to 2250 RPM
Fuel Pressure	Green Arc	.5 PSI to 8 PSI
	Red Line	8 PSI

- Placards: 1. AVOID CONTINUOUS OPERATION BETWEEN 2000 AND 2250 RPM
 2. WHEN FIVE SEATS ARE INSTALLED, SEE WEIGHT AND BALANCE FOR BAGGAGE CAPACITY AND LOADING SCHEDULE.

Airspeed Limits (CAS) : Minimum Control Speed 84 MPH

Weight / C.G. :

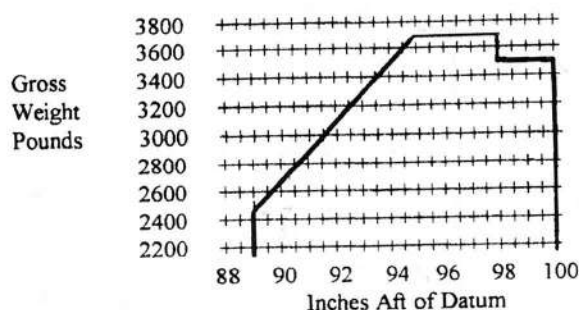

All weight above 3500 pounds to be in usable fuel in the outer panel tanks.

Maximum gross weight 3684 pounds.

Apache Modification Aircraft Corporation
1893 Airport Road
Kalispell, Montana 59901

FAA Approved Airplane Flight Manual Supplement for Piper PA-23 STC No. SA899SW

II. PROCEDURES - No Change.

III. PERFORMANCE

Performance is equal to or better than that given for the unmodified Model PA-23.

* The following STC's may be installed in any combination:

- | | |
|----------|--|
| SA362SW | Rear Baggage Compartment |
| SA371SW | Fiberglass Nose Cone |
| SA452SW | Third Window |
| SA461SW | Rams Horn Control Wheel |
| SA462SW | One Piece Windshield |
| SA463SW | Wheel Well Doors |
| SA497SW | Engine Nose Cowls |
| SA498SW | Dual Brakes |
| SA499SW | Engine Nacelle and Wing Root Fairings |
| SA636SW | Nose, Gear Doors, Nacelle Fairings and Wing Tips |
| SA1294SW | Fiberglass Tail Cone |
| SA4466SW | Fiberglass Engine Cowlings |
| SA5918SW | One Piece Slope Windshield |

FAA APPROVED



Mike Pasion, Manager
Special Certification Branch
Seattle Aircraft Certification Office
Federal Aviation Administration
1601 Lind Avenue S.W.
Renton, WA 98055

DATE

Feb 24, 1999

POWER SETTING TABLE

O-360-A1D
180 Hp.

DATA MEASURED and/or EXTRAPOLATED
FROM PERFORMANCE OF GERONIMO
N4275P — OTHER AIRCRAFT MAY VARY

PA23-160/180

Press. Alt. Feet	Std. Alt Temp *F	99 HP - 55% Rated RPM AND MAN PRESS				117 HP - 65% Rated RPM AND MAN PRESS				135 HP - 75% Rated RPM AND MAN PRESS			Press Alt Feet
		2100	2200	2300	2400	2100	2200	2300	2400	2200	2300	2400	
SL	59	21.2	20.7	20.2	19.7	24.0	23.4	22.8	22.2	26.0	25.4	24.7	SL
1,000	55	21.0	20.5	20.0	19.5	23.8	23.2	22.5	22.0	25.8	25.1	24.5	1,000
2,000	52	20.7	20.3	19.7	19.3	23.5	22.9	22.3	21.8	25.5	24.8	24.2	2,000
3,000	48	20.5	20.0	19.5	19.1	23.2	22.7	22.0	21.5	25.3	24.6	24.0	3,000
4,000	45	20.3	19.8	19.3	18.9	23.0	22.5	21.8	21.3	25.1	24.3	23.8	4,000
5,000	41	20.0	19.6	19.1	18.6	22.7	22.2	21.6	21.1	FT	24.1	23.5	5,000
6,000	38	19.8	19.4	18.9	18.4	22.5	22.0	21.3	20.9	--	FT	23.3	6,000
7,000	34	19.6	19.2	18.7	18.2	22.0	21.8	21.1	20.7	--	--	FT	7,000
8,000	31	19.3	18.9	18.4	18.0	FT	21.5	20.9	20.5				8,000
9,000	27	19.1	18.7	18.2	17.8	--	FT	20.6	20.3				9,000
10,000	23	18.9	18.5	18.0	17.6	--	--	FT	20.1				10,000
11,000	19	18.6	18.3	17.8	17.4	--	--	--	FT				11,000
12,000	16	18.4	18.1	17.6	17.2								12,000
13,000	12	FT	17.8	17.4	17.0								13,000
14,000	9	--	FT	17.1	16.8								14,000
15,000	5	--	--	FT	FT								15,000

To maintain constant power, correct manifold pressure approximately 0.17" HG for each 10* F variation in carburetor air temperature from standard altitude temperature. Add manifold pressure for air temperatures above standard; subtract for temperatures below standard.

GERONIMO PERFORMANCE DATA

Performance Data at 3800 lbs. Gross Weight
All figures, plus or minus 2%

Rate of Climb	2000 Feet Per Minute
Top Speed	200 MPH TAS
Speed at 75% Power	190 - 196 MPH TAS
Speed at 65% Power	184 - 190 MPH TAS
Landing Distance	675 Feet Over 50-ft. Obstacle
Take-Off Distance	650 Feet Over 50-ft. Obstacle
VMC (Figures on Critical Engine)	72 MPH Windmilling Engine 65 MPH Feathered Engine
Single Engine Climb Speed (Sea Level)	750 FPM Clean 150 - 200 FPM, Gear & Flaps Down
Best Angle of Climb Speed (Vx)	87 MPH (77 to 87 depending on weight)
Best Rate of Climb Speed (Vy)	95 - 105 MPH depending on weight
Stall Speeds	54 MPH Vso (Gear & Flaps Down) 60 MPH Clean, Power Off
Service Ceiling	23,000 Feet
Single Engine Ceiling	12,000 Ft. Carburetor Heat Off 10,500 Ft. Full Carburetor Heat
Engines	0-360 A1D 180 HP Lycomings
Recommended Time Between Engine Overhauls	2,000 Hours
Useful Load	1,500 lbs, (depending on installation of oxygen, electronics, etc.) approximately, with a 4,000 lb. gross aircraft.